

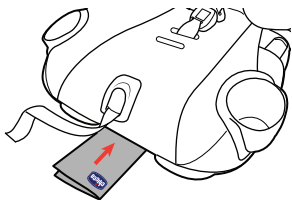

MyFit™

Harness+Booster™ User Guide

For future use,
STORE USER GUIDE in
compartment at front of base.



If you have any problems with your Chicco Child Restraint, or any questions regarding installation or use, please call:

Chicco Customer Service
1-877-424-4226

Please have Model and Serial Number available when you call. These are located on a label on the bottom of the Child Restraint.

For future reference, fill in the information below. The information can be found on the label on the bottom of the Child Restraint.

Model Number: _____

Serial Number: _____

Manufactured In: _____

TABLE OF CONTENTS

Registration and Recall	2
Child Guidelines	4
Safe Use Checklist	6
Important Warnings	8
Best Practices	14
Need Help?	15

CHILD RESTRAINT OVERVIEW

Child Restraint Components	16
LATCH and Tether Storage	20
Selecting Harness/Booster Mode	22
Adjusting Crotch Strap	26
Adjusting Headrest	28
Adjusting Recline	30
Cup Holder	32

VEHICLE INFORMATION

Vehicle Seating Positions	34
Vehicle Seat Belts Harness Mode	36
Vehicle Seat Belts Booster Mode	38
What is LATCH?	40
What is a Tether?	42

HARNESS MODE

Harness Setup	44
Install Using LATCH	50
Install Using LAP-SHOULDER BELT	58
Install Using LAP BELT ONLY	64
Securing Child with Harness	70
Securing Child Checklist	82

BOOSTER MODE

Booster Seat Setup	84
Booster Seat Installation	96
Securing Child in Booster Seat	102
Convert to Harness Mode	108
Securing Child Checklist	110

ADDITIONAL INFORMATION

Installation on an Aircraft	112
Cleaning and Maintenance	114

Please complete the Registration Card that came with your Child Restraint and mail it promptly.

Child restraints could be recalled for safety reasons. You must register this restraint to be reached in a recall. Send your name, address, e-mail address if available, and the restraint's model number and manufacturing date to:

Artsana USA, Inc.
1826 William Penn Way
Lancaster, PA 17601
or call 1-877-424-4226

or register online at <http://www.chiccouusa.com/carseatregistration.aspx>

For recall information, call the U.S. Government's Vehicle Safety Hotline at 1-888-327-4236 (TTY: 1-800-424-9153), or go to <http://www.NHTSA.gov>.

PAGE INTENTIONALLY LEFT BLANK

CHILD GUIDELINES

HARNES MODE is designed for children who are at least 2 years old. **ONLY** use this Child Restraint if the child meets **BOTH** of the following Weight and Height requirements:

- Weight is between 25 and 65 pounds (11.4 and 29.5 kg).
- Height is 54 inches (137 cm) tall or less.

BOOSTER MODE is designed for children who are at least 4 years old. **ONLY** use this Child Restraint if the child meets **ALL** of the following requirements:

- Weight is between 40 and 100 pounds (18 and 45.3 kg).
- Height is between 38 to 57 inches (97 - 145 cm).
- Demonstrates an ability to sit relatively still and properly in a seat belt at all times.

CHILD GUIDELINES

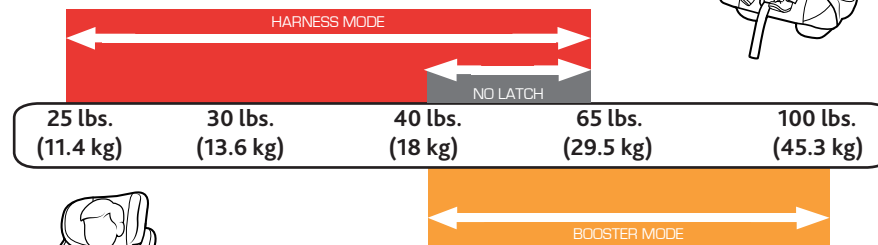
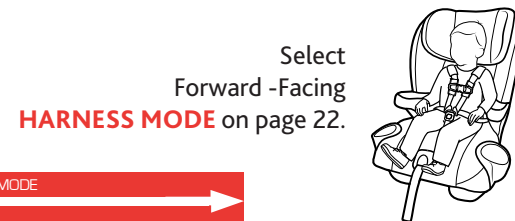

SAFE USE CHECKLIST

⚠ YOUR CHILD'S SAFETY DEPENDS ON YOU! You MUST follow the detailed instructions in this User Guide to ensure the steps below are performed correctly!

- Make sure your child meets the age, weight, and height requirements:**
Refer to the "Child Guidelines" section on page 4.

- Choose the proper Child Restraint configuration:**

HARNES MODE requirements on page 23

BOOSTER MODE requirements on page 25

- Select a safe seating location in your car:**

HARNES MODE requirements on page 35

BOOSTER MODE requirements on page 35

SAFE USE CHECKLIST

- Ensure that the Child Restraint is properly leveled when installed:**

HARNES MODE requirements on page 48

BOOSTER MODE requirements on page 98

- Check for a snug fit in your car when using in HARNES MODE :**
While holding Child Restraint near belt path used, pull side to side and forward. Belt should remain tight and Child Restraint should not move more than 1" (25 mm) from vehicle seat back or side-to-side.

- Secure your child:**

HARNES MODE requirements on page 70

BOOSTER MODE requirements on page 102



FAILURE TO FOLLOW THESE INSTRUCTIONS AND THE PRODUCT LABELS CAN RESULT IN SERIOUS INJURY OR DEATH TO YOUR CHILD.

Take Time to Read This User Guide

- Carefully read and understand all instructions and warnings in this User Guide. Your child's safety depends on you knowing how to setup, install and use this Child Restraint properly.
- Before installing this Child Restraint in a vehicle, be sure to also check the vehicle owner's manual for information on proper installation.
- **NEVER** allow others to use this Child Restraint until they have read and understood all instructions in this User Guide.
- This Child Restraint is not intended for use outside of the vehicle.

Make Sure Child Fits This Child Restraint

- Use **ONLY** in **HARNES** **MODE** with children who weigh between 25 lbs (11.4 kg) and 65 lbs (29.5 kg) and whose height is 54 inches (137 cm) or less. Determine the right installation setup for your child's age, weight and height.



Make Sure Child Fits This Child Restraint

- Use **ONLY** in **BOOSTER MODE** with children who weigh between 40 lbs (18 kg) and 100 lbs (45.3 kg) and whose height is 38 - 57 inches (97 - 145 cm). Determine the right installation setup for your child's age, weight, height and ability to sit properly at all times.

Secure Child Properly

- Snugly adjust the harness around your child. A loose harness could cause the child to be ejected in a sudden stop or crash, resulting in serious injury or death.

A snug strap should not allow any slack. It lies in a relatively straight line without sagging. It does not press on the child's flesh or push the child's body into an unnatural position.

- **NEVER** use clothing or blankets that interfere with fastening or tightening the harness. An unsecured child could be ejected in a sudden stop or crash!

To keep child warm, place a blanket over child and restraint **AFTER** you have properly secured child in harness.



Secure Child Properly

- **ALWAYS** check to make sure the buckle is securely latched. If the buckle separates, child could be killed or seriously injured.
- Do not allow children to play in or around the Child Restraint.
- **ALWAYS** keep child properly secured whenever child is in Child Restraint.
- Position Lap-Shoulder Belt on your child in this Booster Seat. A loose or improperly positioned Lap-Shoulder Belt could cause the child to be ejected in a sudden stop or crash, resulting in serious injury or death.
- Make sure vehicle Lap-Shoulder Belt is not loose on child in this Booster Seat. The belt must be kept snug across child's thighs and resting on the shoulder and across the center of the chest.

Install Child Restraint Correctly

- **DO NOT PLACE THIS CHILD RESTRAINT IN VEHICLE SEATING LOCATION WITH A FRONTAL AIR BAG, UNLESS THE AIR BAG CAN BE TURNED OFF.** If the airbag inflates, it can cause serious injury or death to your child. For vehicles with side air bags, refer to your vehicle owner's manual for information on your child restraint installation.



Install Child Restraint Correctly

- **ALWAYS** install this Child Restraint in a back seat if possible.

According to accident statistics, children are safer when properly restrained in the rear seating positions rather than in the front seat.

- **NEVER** install in rear facing, side facing or on the back of a folded down vehicle seat.
- **ALWAYS** use this Child Restraint in the forward-facing orientation.
- **ALWAYS** secure this Child Restraint with the vehicle's child restraint anchorage system (LATCH) if available OR the vehicle seat belt when used in harness mode. Refer to Page 5 for proper use/child weight limits when installing with LATCH.
- **DO NOT** use the lower anchors of the child restraint anchorage system (LATCH system) with the internal harness of the Child Restraint when restraining a child weighing more than **40 lbs (18 kg)**.
- **NEVER** use this seat in booster mode with only a Vehicle Lap Belt.
- Use **ONLY** the vehicle's lap and shoulder belt system when restraining the child in this Booster Seat.



Install Child Restraint Correctly

- **ALWAYS** secure this seat, with the LATCH system or the vehicle's lap-shoulder belt when **unoccupied**. It could injure other occupants in a sudden stop or crash.
- **ALWAYS** use the top tether strap on this Child Restraint when used in harness mode, if a tether anchor is available.
- **NEVER** use Child Restraint in a vehicle seating position where it cannot be secured tightly when installed for harness mode. A loosely installed Child Restraint will not protect your child in a crash.
- **DO NOT** install this Child Restraint using an inflatable seat belt for harness mode. The interaction of the inflatable portion of the vehicle's belt with this Child Restraint **can result in serious injury or death**. Install using LATCH instead, or move the Child Restraint to a position with a suitable seat belt type. Refer to your vehicle owner's manual for instructions for use with this Booster Seat.

Ensure Child's Safety When Using Child Restraint

- **STRANGULATION HAZARD:** Your child can strangle in a loose Restraint Harness. Never leave your child unattended in the vehicle.



Check Condition of Restraint

- **DO NOT** use if the Harness or LATCH straps are cut, frayed or damaged.
- **DO NOT use this Child Restraint if it is more than 8 years old.** Check manufacturer's label on underside of Child Restraint for the "Do Not Use After" date.
- **DO NOT use any accessories, pads or products not included with this Child Restraint, unless approved by Chicco USA.** Doing so will void the warranty of this Child Restraint.
- You **MUST** replace this Child Restraint if it has been involved in a crash, even if you cannot see visible damage. A damaged Child Restraint may not protect your child in a future crash.
- **Never** use the harness or adjuster strap to lift or carry this Child Restraint. Always carry this Child Restraint by the tether strap or shell.
- **Do not modify your Child Restraint.**
- **NEVER** remove harness from Child Restraint without the proper removal and installation instructions available from Chicco USA. Contact us by visiting the Chicco website at www.chiccousa.com or call 1-877-424-4226.
- **Do not use Child Restraint if any component is damaged, broken, or missing parts.** Call 1-877-424-4226 to find out if the damaged part or parts can be replaced.

- Ensure all vehicle occupants are properly restrained before traveling. Unrestrained occupants can be thrown around and may be seriously injured or seriously injure other occupants in a sharp turn, sudden stop or crash.
- Do not leave loose objects, such as books, bags, etc., in the back of the vehicle. In the event of a sharp turn, sudden stop, or crash, loose objects can be thrown around and possibly cause serious injury to vehicle occupants.
- Cover the Child Restraint when the vehicle is parked in sunlight. Parts of a Child Restraint can become very hot if left in the sun. Contact with these parts can burn a child's skin. Always check the surface of any metal or plastic parts before putting your child in the Child Restraint.
- To avoid strangulation, do not allow children to play with vehicle seat belts. If possible, move unused belts out of reach.
- Do not use anything to raise the Child Restraint off the vehicle seat such as a noodle or towel. In a sharp turn, sudden stop, or crash, the Child Restraint could slide and potentially cause serious injury.
- Never use a second-hand Child Restraint with an unknown history.
- Never use any accessories that are not included with this Child Restraint, unless specifically approved by Chicco. For more information, go to www.chiccousa.com.

Need Help Securing Your Child Restraint?

The following sources are available to help ensure your Child Restraint is properly installed:

- Contact Chicco, USA by visiting our website at www.chiccousa.com or calling our Customer Service 1-877-424-4226. Please have Model and Serial Number available when you call. These are located on a label on the bottom of the Child Restraint.
- Refer to your vehicle manual for Child Restraint installation tips.
- Contact a certified Child Passenger Safety Technician in your area by visiting safercar.gov and select "Find Local Child Seat Help" or call 1-866-SEAT CHECK (1-866-732-8243).

CHILD RESTRAINT COMPONENTS

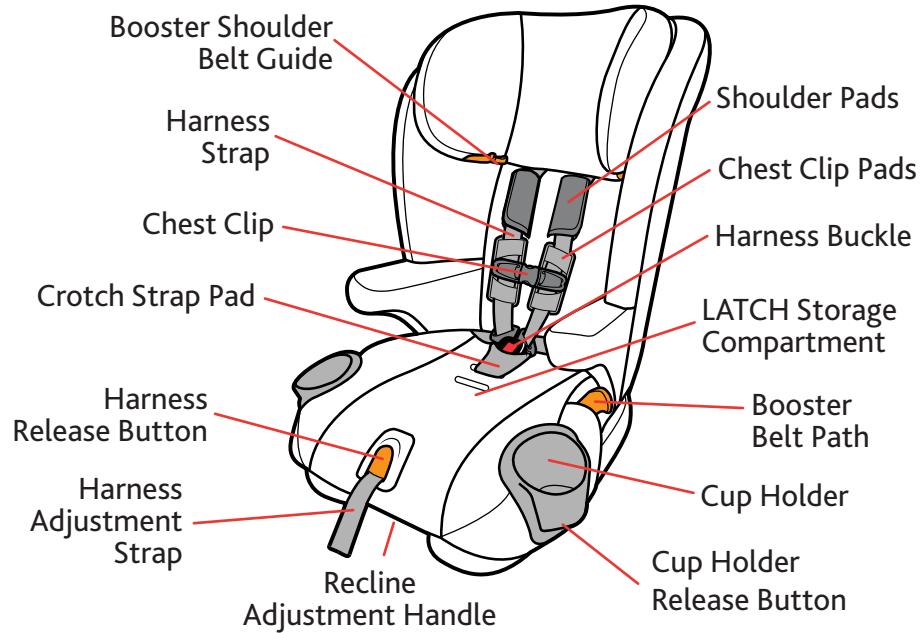

CHILD RESTRAINT COMPONENTS

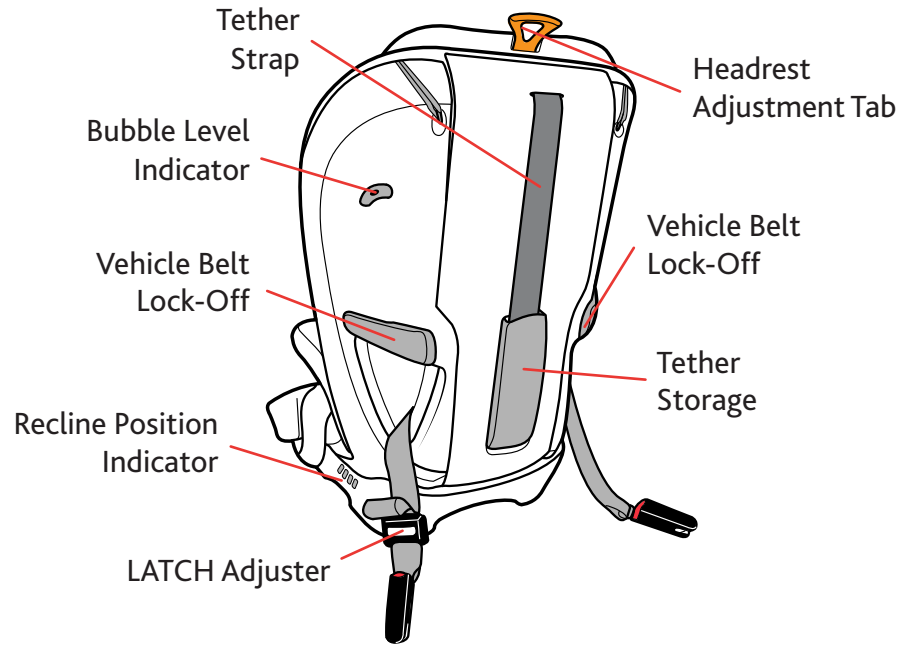

CHILD RESTRAINT COMPONENTS

TETHER:

- A** Tether Strap
- B** Tether Strap Adjuster
- C** Tether Hook

LATCH:

- D** LATCH Adjuster
- E** LATCH Strap
- F** LATCH Connectors

CHILD RESTRAINT COMPONENTS

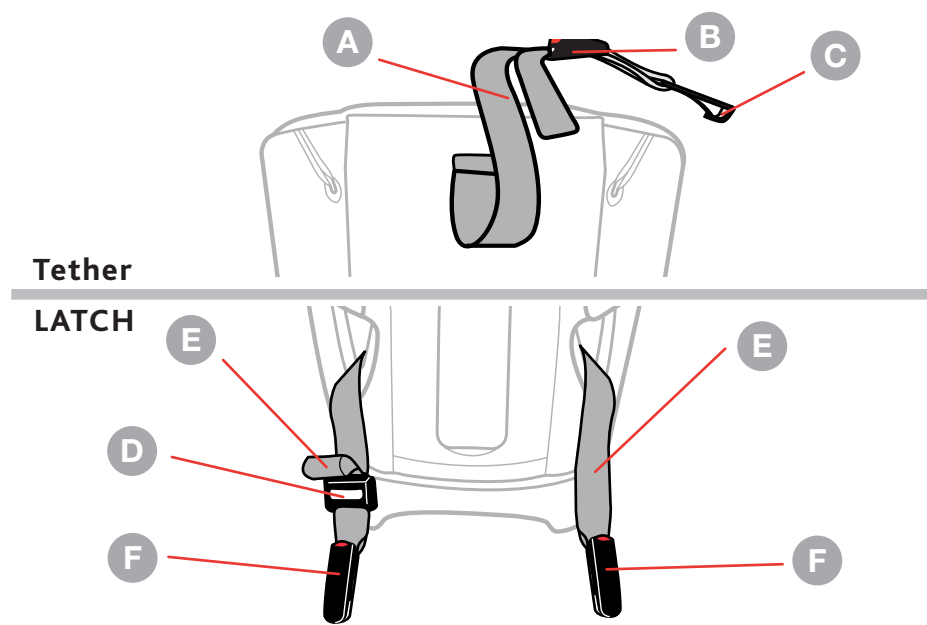

LATCH AND TETHER STORAGE

⚠ Always make sure LATCH Components are properly stored in the compartments when not in use.

LATCH STORAGE:

- 1 Pull forward on the Seat Bottom Pad to locate the LATCH Storage Compartment.
- 2 Open the compartment door and store both LATCH straps in the compartments. Fold the LATCH straps as show (2a). Make sure the LATCH Storage Compartment is properly closed before replacing fabric.

TETHER STORAGE:

- 3 Store Tether in the compartment in the back of Child Restraint when not in use. Attach Tether Hook onto bar and pull on strap to remove slack. Make sure compartment door is properly closed.

LATCH AND TETHER STORAGE

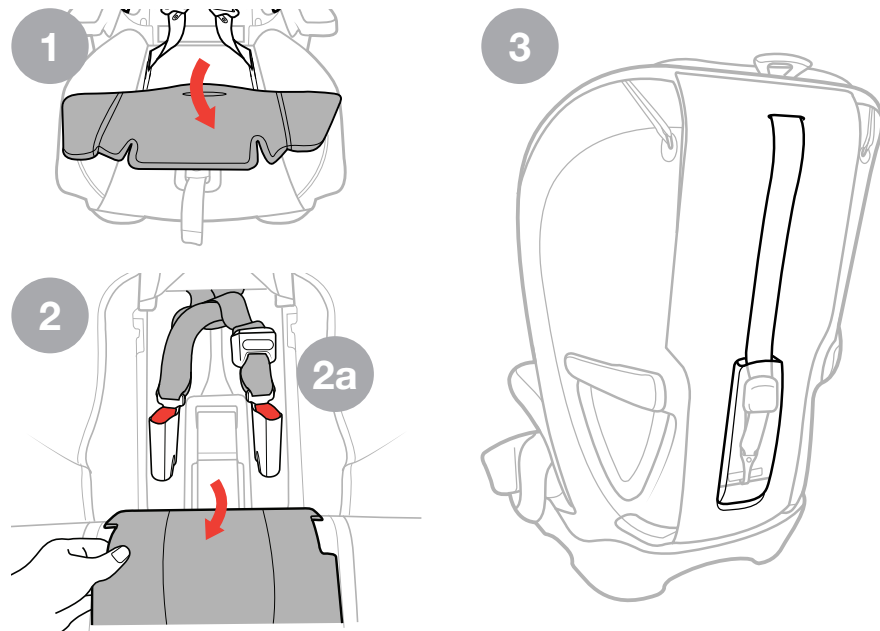

SELECT HARNESS MODE

⚠ WARNING! HARNESS MODE use of this Child Restraint is ONLY for children who meet ALL of the requirements shown here. If the child is not within these requirements because they are too small, select a different child seat (select a rear facing child restraint). If the child is not within these requirements because the child is too large, review the BOOSTER MODE guidelines on page 25.

Use **HARNESS MODE** with children:

- Who are at least two years old.
- Who weigh between 25 and 65 lbs (11.4 – 29.5 kg)
- Who are 54" (137 cm) tall or less.
- When Harness Straps can be positioned at or above the child's shoulders*.

See Harness Height Adjustment on page 74.



SELECT HARNESS MODE

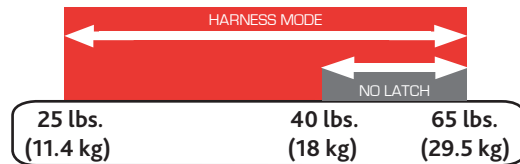

SELECT BOOSTER MODE

⚠ WARNING! BOOSTER MODE use of this Child Restraint is **ONLY** for children who meet ALL of the requirements shown here. If the child is not within these requirements because the child is too small, review the **HARNES** MODE guidelines on page 23.

Use **BOOSTER MODE** with children:

- Who are at least four year old.
- Who weigh between 40 and 100 lbs (18 – 45.3 kg).
- Who are 38" to 57" (97 - 145 cm) tall.
- Who demonstrate an ability to sit relatively still and properly in a seat belt at all times.

See Adjusting Shoulder Belt Guide Height on page 100.

SELECT BOOSTER MODE

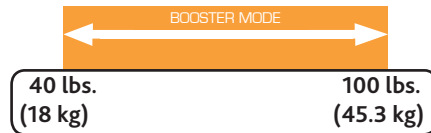

ADJUSTING CROTCH STRAP

- 1 Undo the Chest Clip and Buckle Tongues. Remove Crotch Strap Pad (see page 92). Pull forward on the Seat Bottom pad and push the Crotch Strap through the slot on the Seat Bottom pad.
- 2 With the Crotch Strap in the Position 1 (**2a**), guide the Crotch Strap forward through the Crotch Strap compartment (**2b**) and pull the Crotch Strap into Position 2 (**2c**). Thread Crotch Strap through the correct crotch strap opening and reposition the Seat Bottom pad. Reverse this step to move the Crotch Strap back to Position 1.

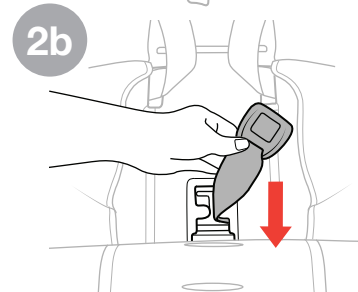
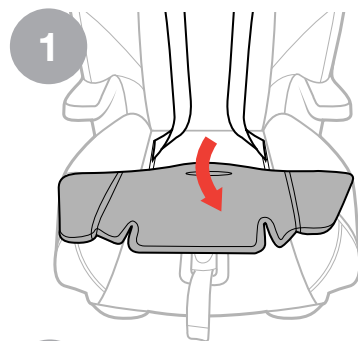

ADJUSTING CROTCH STRAP

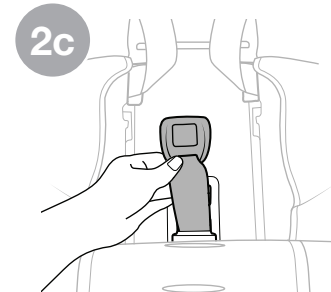
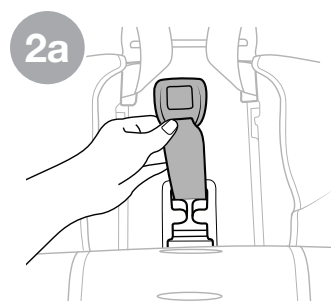

ADJUSTING HEADREST

- 1 Correctly fit the Child Restraint to your child by adjusting the Headrest. Pull up on the Headrest Adjustment Tab located on the back of the Child Restraint, and adjust the Headrest up or down.
- 2 Make sure the Headrest is locked into position. Release the Headrest Adjustment Tab and slightly raise/lower the Headrest until you hear a click, indicating that the Headrest is locked into position.

The Headrest has 9 height positions to allow the Child Restraint to grow with your child. Ensure that the child's head is positioned correctly within the Headrest and that the Shoulder Belt is positioned correctly at or just above the child's shoulders.

ADJUSTING HEADREST

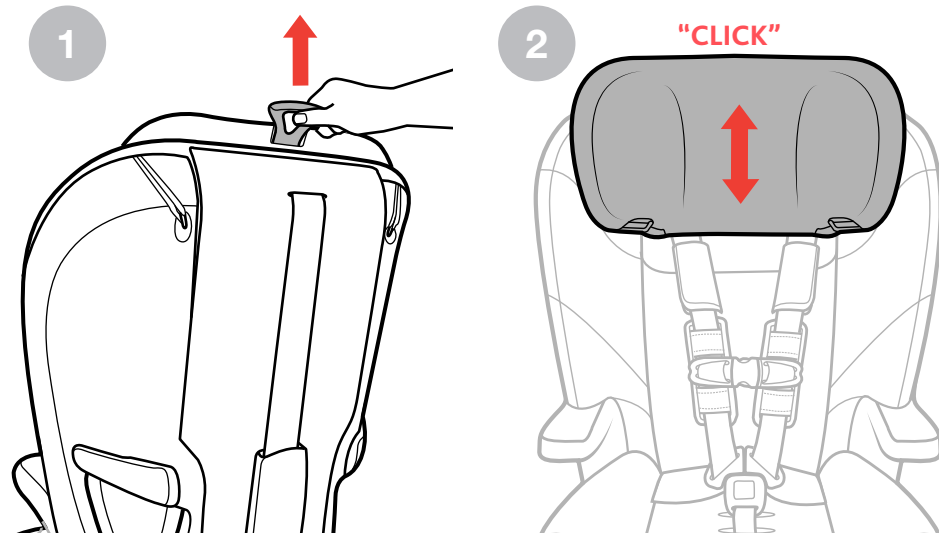

ADJUSTING RECLINE

- 1 Squeeze the Recline Adjustment Handle on the front of the Child Restraint and adjust to an upright or reclined position, as desired (1a).

Make sure the seat is in a locked position and that the bubble level is between the lines for the appropriate installation mode.

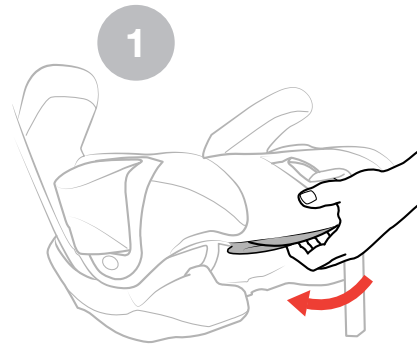

CUP HOLDER

⚠ WARNING - Do NOT use Cup Holder to hold hot liquids. **PLASTIC CONTAINERS ONLY** - No glass or metal containers. Only use cups with less than 12 oz. (355 ml) capacity. Never place sharp or pointed objects in Cup Holder. In a crash these objects could hit you or your child and cause serious injuries.

ATTACHING THE CUP HOLDER:

- 1 Match the "R" and "L" Cup Holders to the Child Restraint, as shown.
- 2 Slide the Cup Holder into the Child Restraint. Make sure the Cup Holder Lip fits behind the groove on the Child Restraint, as shown. Push down on the Cup Holder until it clicks into place. Repeat for the other side.

REMOVING THE CUP HOLDER

- 3 To remove, press the button located on the bottom edge of the Cup Holder. Lift up to remove.

CUP HOLDER

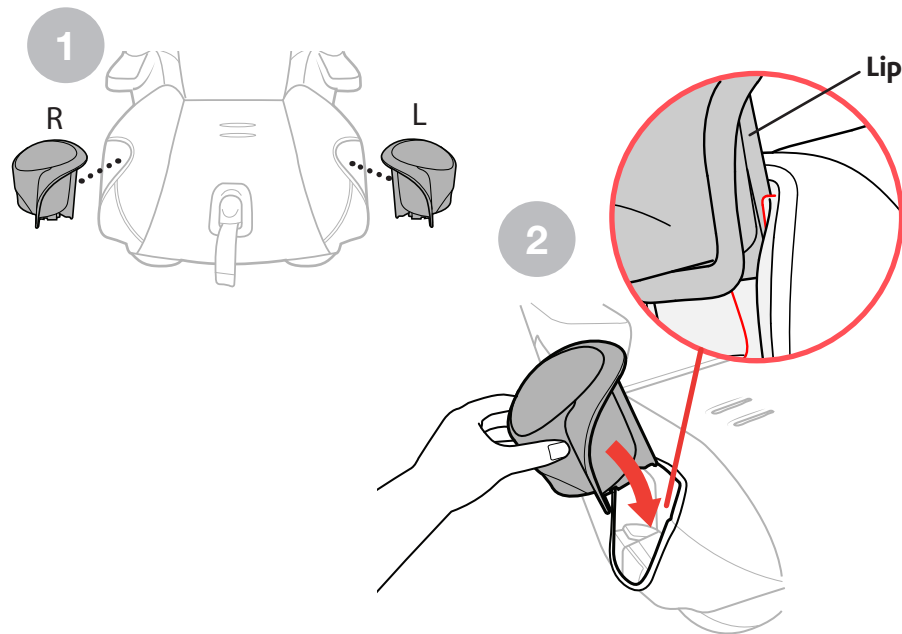

VEHICLE SEATING POSITIONS



⚠ WARNING! WHEN USING THIS CHILD RESTRAINT, DO NOT PLACE THIS CHILD RESTRAINT IN A VEHICLE SEATING LOCATION WITH A FRONTAL AIR BAG, UNLESS THE AIR BAG CAN BE TURNED OFF.

The back seat is the safest place for children 12 and under. See your vehicle owner's manual for Booster Seat installation and instructions.

VEHICLE SEATING POSITIONS

Some vehicles have no seating positions which are compatible with this Child Restraint. If in doubt, contact the vehicle manufacturer for assistance. Only forward-facing vehicle seats should be used with this Child Restraint.



Do not use on a folded down vehicle seat back.



Make sure no more than 3 inches of the Child Restraint base is past the edge of the vehicle seat.

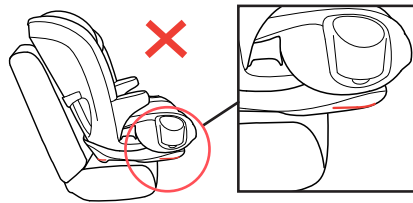

When using the seat in **BOOSTER MODE**, always install in a vehicle seat with a 3-point seat belt (shoulder belt and lap belt). **NEVER** use lap belt only.



VEHICLE SEAT BELTS - HARNESS MODE

The information in this section only applies to installation with vehicle seat belts in **HARNESS MODE**.

Vehicle seat belts differ from vehicle to vehicle. Refer to your vehicle owner's manual for specific information about seat belts and their use with Child Restraints. For simplest installation use LATCH - Refer to page 40 for details.

Shoulder belt with switchable retractor:

Putting the shoulder belt in the locked/switched mode as the last step is optional. The shoulder belt Lock-Off replaces the need for the locked/switched mode.

VEHICLE SEAT BELTS - HARNESS MODE

The following types of vehicle belts **MUST NOT** be used to install this Child Restraint in **HARNESS MODE**. If any of the belt types listed below are in the chosen seating position, choose another vehicle seating position OR use LATCH if available.

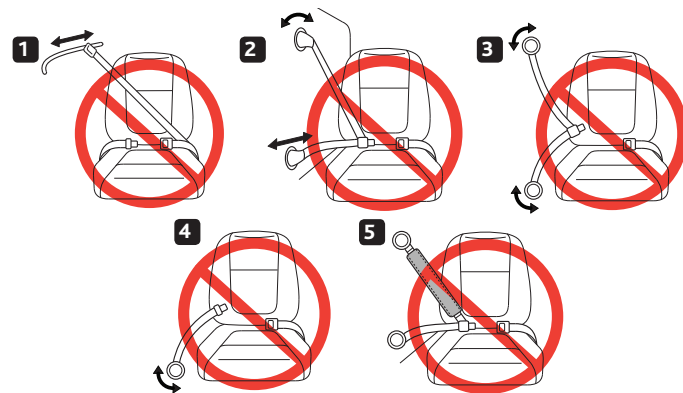

1. Motorized (automatic) vehicle belts.
2. Door mounted vehicle belts.
3. Lap-shoulder Belts with 2 retractors (unless Lap Belt has a "Lock Mode").
4. Non-Locking (ELR) Lap Belts.
5. Inflatable seat belts.

The information in this section only applies to installation with vehicle seat belts in **BOOSTER MODE**.

Shoulder belt with switchable retractor:

Refer to your vehicle owner's manual for information regarding switchable retractors and Booster Seat use.

Inflatable seat belts:

Refer to your vehicle owner's manual for instructions for use with this Booster Seat.

The following types of vehicle belts **MUST NOT** be used to install this Child Restraint in **BOOSTER MODE**.

If any of the belt types listed below are in the chosen seating position, you must choose another vehicle seating position.

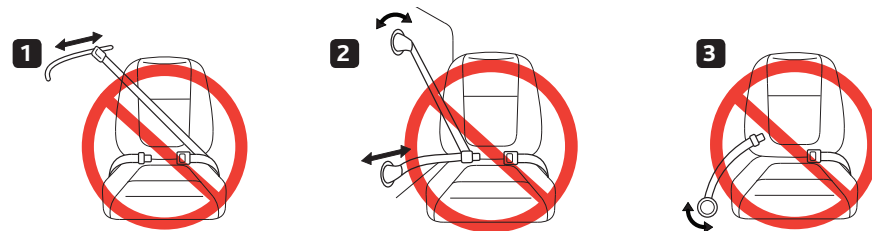

1. Never use a Lap Belt with motorized Shoulder belt.

3. Never use any type of Lap-Only Belt.

2. Never use vehicle belts that are attached to the door or that move along a track.

WHAT IS LATCH?

⚠ WARNING: This Child Restraint is designed to be used with lower LATCH anchors at the standard spacing (11 inches (28 cm)) **ONLY!** Refer to vehicle owner's manual for information about LATCH and Child Restraint installation positions.

LATCH = Lower Anchors and Tethers for Children

United States Motor Vehicle Safety Standards have defined a system for installing Child Restraints in vehicles called LATCH. **In Harness Mode, LATCH may ONLY be used IN PLACE OF vehicle belt if the vehicle is equipped with LATCH anchor points. DO NOT use both the seat belt and LATCH at the same time. Please refer to the vehicle owner's manual for designated LATCH locations in vehicles.**

LATCH in the vehicle consists of a top tether anchor point and two lower anchor points. Some vehicle owner's manuals use the term "**ISOFIX**". **LATCH** can also be used in vehicle seating positions equipped with **ISOFIX**.

If the vehicle is equipped with **LATCH**, the vehicle lower anchor points may be visible at the seat crease. If not visible, the seating position may be marked with a symbol (fig. a) or a colored dot. Check the vehicle owner's manual for vehicle top tether anchor locations. They may be identified using one of the anchor symbols (fig. b or fig. c).

WHAT IS LATCH?

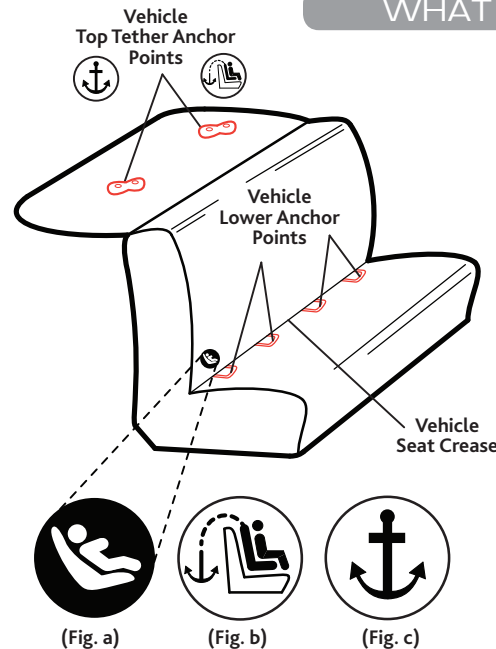

WHAT IS A TETHER?



Tether anchor locations vary from vehicle to vehicle. Check your vehicle owner's manual and look for the tether anchor symbol as shown. A tether reduces movement of a forward facing child restraint in a crash and helps to achieve a tight installation.

Vehicle tether anchors can be found in many different locations. Some of the typical locations are shown here. Refer to your vehicle owner's manual for exact locations, anchor identification, and requirements.

WHAT IS A TETHER?

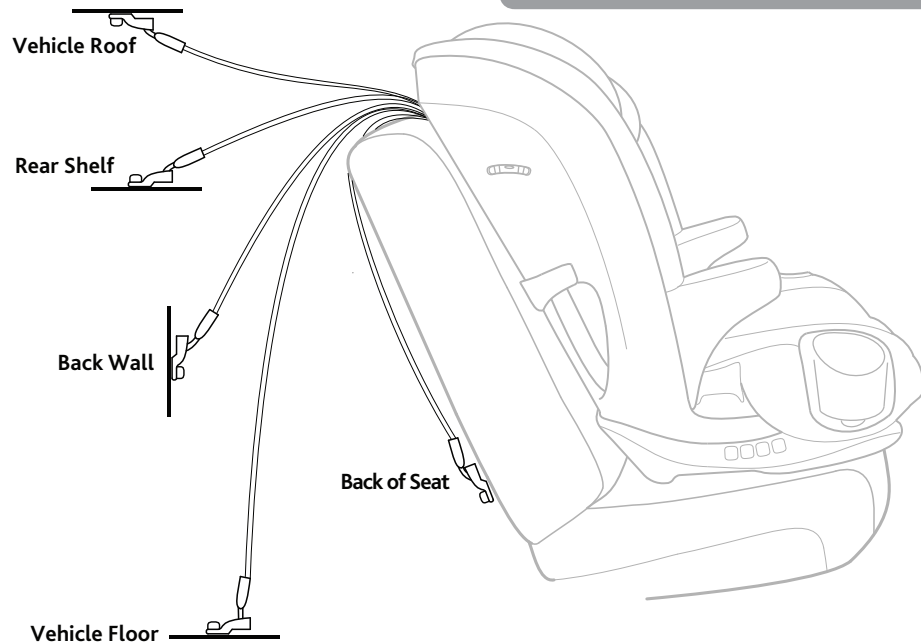

HARNES SETUP

- 1 IF TETHER ANCHOR IS AVAILABLE IN YOUR VEHICLE - Before placing the Child Restraint in the vehicle, remove Tether from the tether compartment. If a tether anchor is not available, the Tether should be stored properly (See page 20).
- 2 See page 34 for "Vehicle Seating Positions" before installing. Make sure the vehicle is on a level surface, if possible.

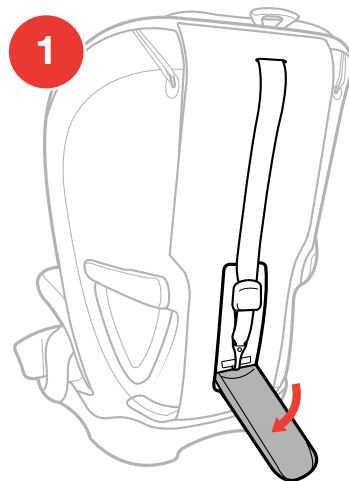

HARNES SETUP

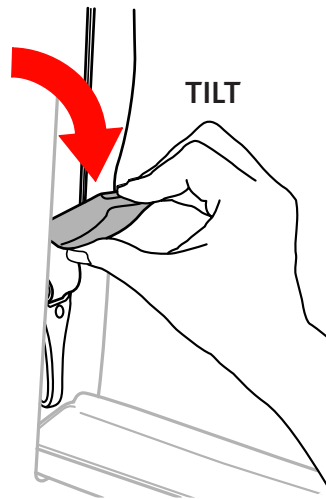

HARNES SETUP

- 3 Place the Child Restraint on the vehicle seat making sure the installation lines (located on the Seat Base) are **PARALLEL** with the vehicle seating surface.
- 4 Check that the headrest of the vehicle seat does not interfere with the Headrest of the Child Restraint.

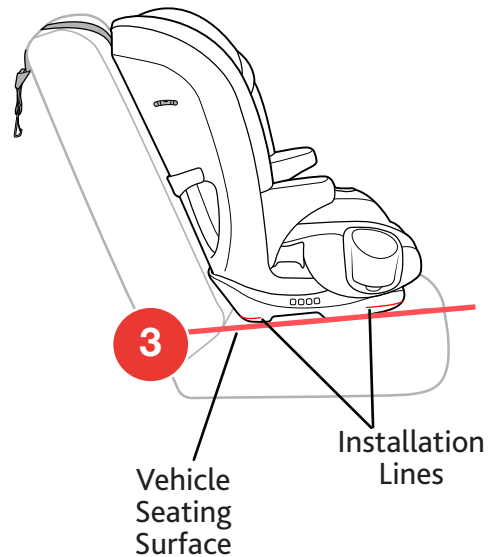

If the vehicle headrest pushes the Child Restraint forward, check your vehicle owner's manual to see if the headrest removal is permitted. If so, follow the vehicle owner's manual to remove the headrest. If it is not permitted, raise the vehicle headrest or move the Child Restraint to a different vehicle seating location.

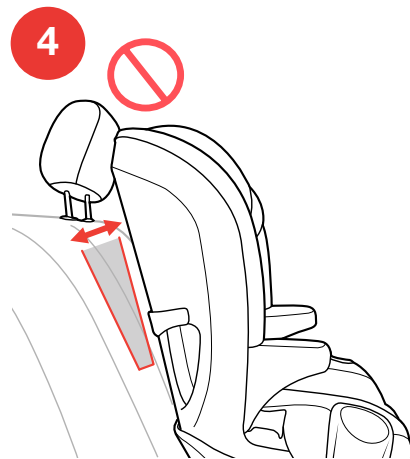

HARNES SETUP



HARNES SETUP

- 5 With the Child Restraint facing forward on selected vehicle seat; make sure it is not blocking the vehicle belt buckle. Lay Tether Strap over the back of the vehicle seat.
- 6  **Installation on a Level Surface:** Locate the Bubble Level Indicator label and re-adjust the seat recline to any position that the Bubble falls between the lines.
-  **Installation on a Slope:** If vehicle is on a slope, adjust the seat recline to position 3 or position 4 only.
- 7 Check to make sure the install line has remained parallel to the vehicle seating surface (see step 3 pg. 47).

Installation Options:

- *LATCH installation continued on page 50.*
- *Lap-Shoulder Belt installation continued on page 58.*
- *Lap Belt Only installation continued on page 64.*

HARNES SETUP

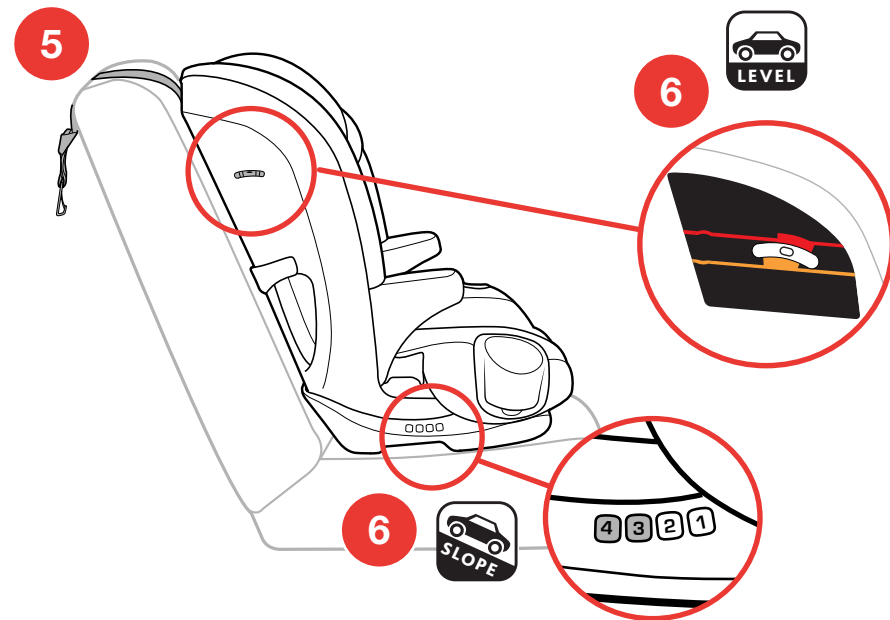

INSTALL USING LATCH

⚠ Do not use the LATCH anchors of the Child Restraint anchorage system with the internal harness of the child restraint when restraining a child weighing more than 40 lbs (18 kg). Always use the Top Tether.

⚠ When installing with LATCH in vehicle equipped with inflatable seat belts, the unused seat belt should NOT be buckled behind the Child Restraint System as this will engage the inflatable portion of the belt.

- 1 If LATCH anchors are out and in correct position skip to Step 6 (pg 54). Undo the snap attaching the Armrest Fabric to the Backrest Seat Pad. Repeat this step for the other side.
- 2 Pull forward on the Seat Bottom Pad and lift up on the Backrest Seat Pad to locate the LATCH Storage Compartment.
- 3 Open the compartment door and remove LATCH straps.

INSTALL USING LATCH

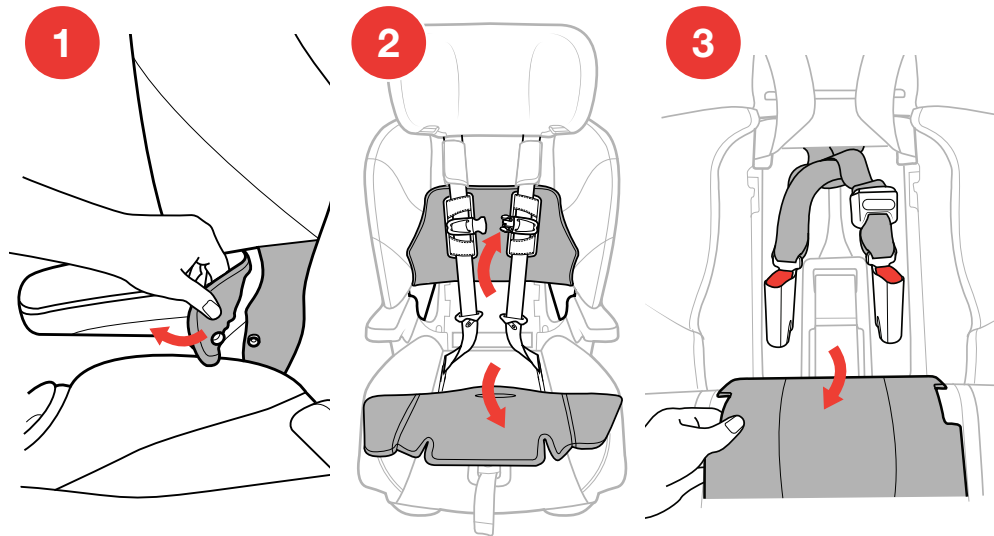

INSTALL USING LATCH

- 4** Thread the LATCH connectors behind the seat fabric and out the side openings on the seat back, as shown.

Loosen **BOTH** LATCH Adjuster straps to their full length.

- 5** Make sure the LATCH straps lay flat against the seat back (**5a**). If the straps are twisted they will not move freely from side to side. Then close the LATCH Connector Storage compartment door and replace **BOTH** seat pads (**5b**). Make sure to re-attach both snaps on the Backrest Seat Pad to the Armrest Fabric.

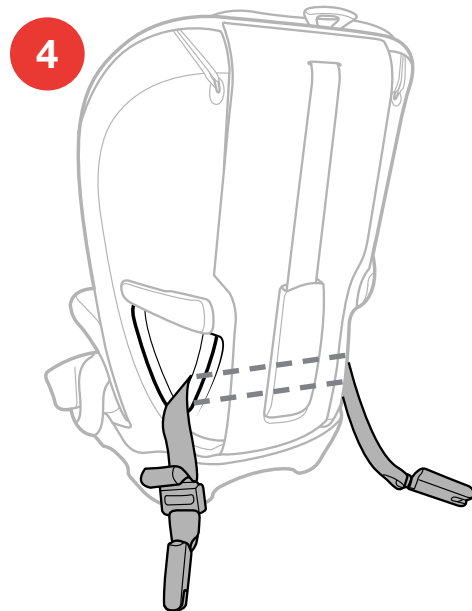

INSTALL USING LATCH

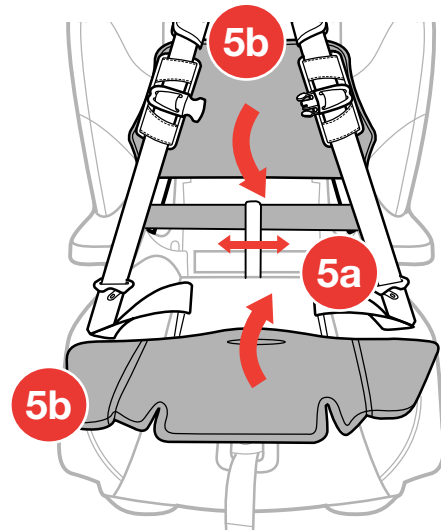

INSTALL USING LATCH

Reminder: If using Tether Strap, make sure to lay it over the seat before installing in LATCH mode. "IF TETHER ANCHOR IS AVAILABLE IN YOUR VEHICLE - Before placing the Child Restraint in the vehicle, remove Tether from the tether compartment. If a tether anchor is not available, the Tether should be stored properly."

- 6 Locate the LATCH anchor bars in your vehicle. Attach both LATCH Connectors to the vehicle LATCH anchor bars.

INSTALL USING LATCH

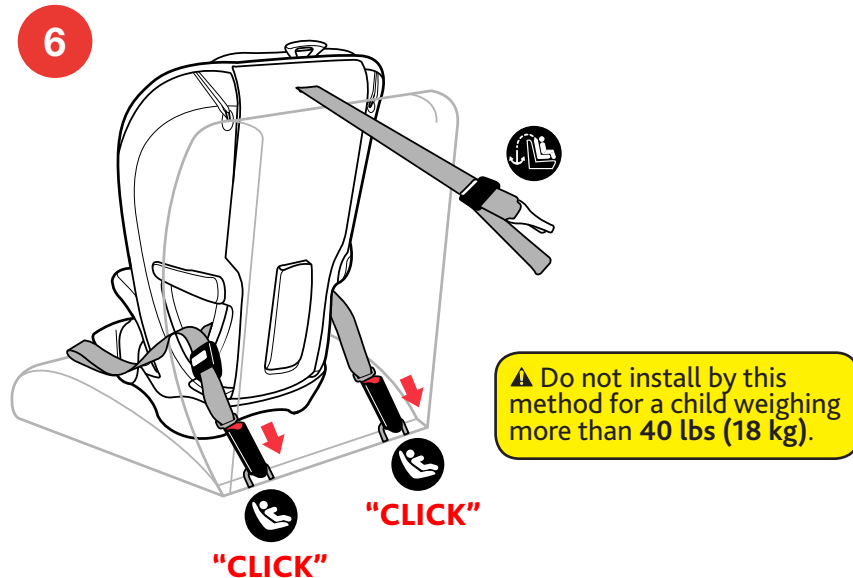

INSTALL USING LATCH

- 7 While pushing down on the Child Restraint (7a), pull on the LATCH Adjuster strap to tighten (7b).
- 8 Locate Tether Anchor in your vehicle. Attach Tether Hook and pull Tether Adjuster strap to tighten.

CHECK YOUR WORK

- ✓ Hold Child Restraint at each side near forward-facing vehicle belt path. Pull side to side and forward. Child Restraint should not move more than 1" (25 mm) from vehicle seat back or side-to-side.
- ✓ Make sure Bubble is between lines on label. If necessary, loosen the LATCH and Tether Straps, re-adjust recline and repeat installation steps to make sure Child Restraint is installed properly.
- ✓ Check installation before every use!

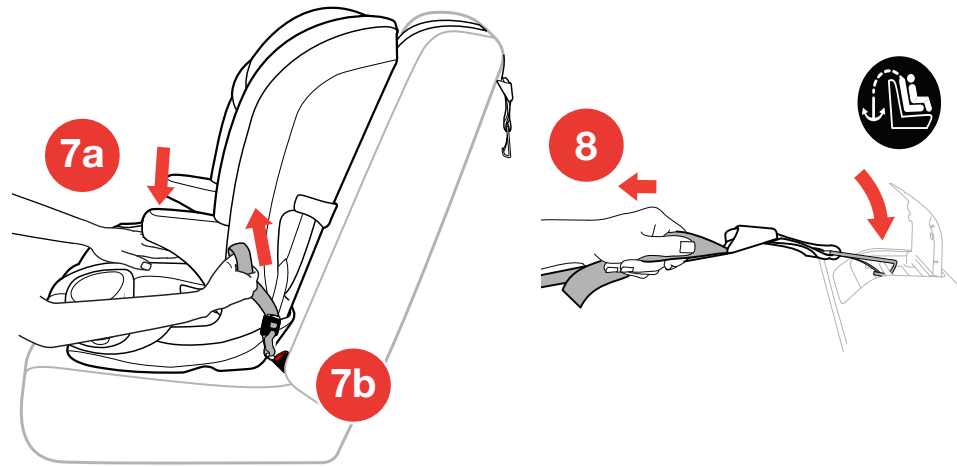

INSTALL USING LATCH

INSTALL USING LAP-SHOULDER BELT

- 1 Undo the snap attaching the Armrest Fabric to the Backrest Seat Pad. Repeat this step for the other side.
- 2 Route vehicle lap-shoulder belt through the red **HARNES MODE** seat belt path on the side of Child Restraint.

INSTALL USING LAP-SHOULDER BELT

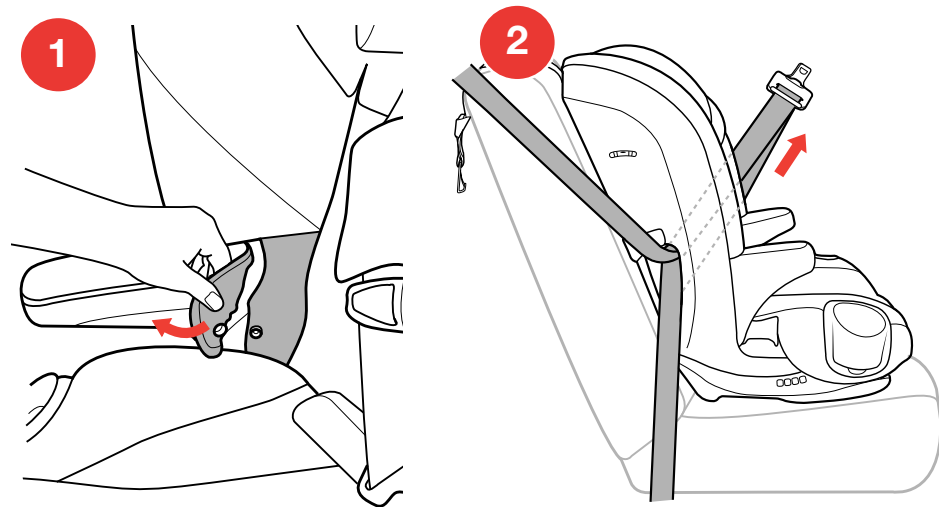

INSTALL USING LAP-SHOULDER BELT

- 3** Lift up on the Backrest Seat Pad. Pass the vehicle belt along the back of the Child Restraint and pull the vehicle belt down through the red **HARNES MODE** seat belt path on the opposite side of the Child Restraint.
- 4** Buckle the vehicle belt. Replace the Backrest Seat Pad, make sure to re-attach the snaps on the Backrest Seat Pad to the Armrest Fabric.

INSTALL USING LAP-SHOULDER BELT

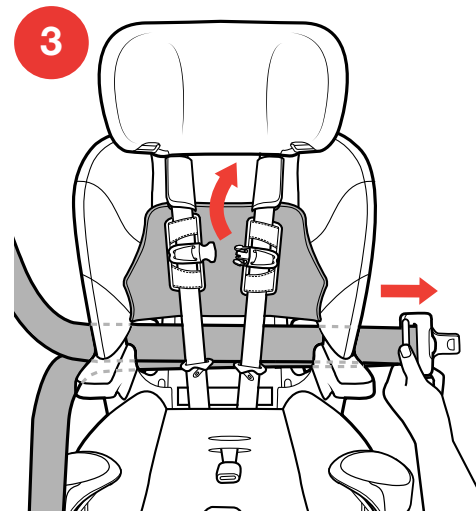

INSTALL USING LAP-SHOULDER BELT

- 5 While pushing down on the Child Restraint (5a) pull the vehicle shoulder belt (5b) to tighten vehicle lap belt.
- 6 While still pulling the shoulder belt tight, slide the vehicle shoulder belt into the Lock-Off. Always use the Lock-Off on the opposite side of the vehicle belt buckle.
- 7 Locate Tether anchor in your vehicle. Attach Tether Hook. Pull Tether Adjuster strap to tighten.

CHECK YOUR WORK

- ✓ Hold Child Restraint at each side near FORWARD-FACING vehicle belt path. Pull side to side and forward. Vehicle belt should remain tight and Child Restraint should not move more than 1" (25 mm) from vehicle seat back or side-to-side.
- ✓ Make sure Bubble is between lines on label. If necessary, loosen the vehicle belt and Tether, re-adjust recline and repeat installation steps to make sure Child Restraint is installed properly.
- ✓ Check installation before every use!

INSTALL USING LAP-SHOULDER BELT

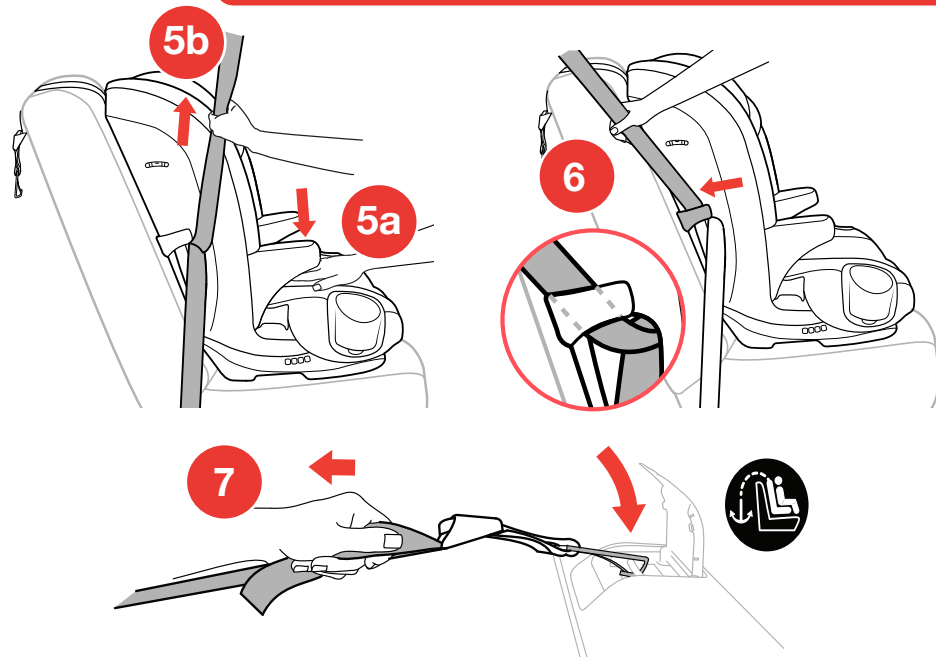

INSTALL USING LAP BELT ONLY

- 1 Undo the snap attaching the Armrest Fabric to the Backrest Seat Pad. Repeat this step for the other side.
- 2 Route vehicle lap belt through the red **HARNES MODE** seat belt path on the side of Child Restraint.

INSTALL USING LAP BELT ONLY

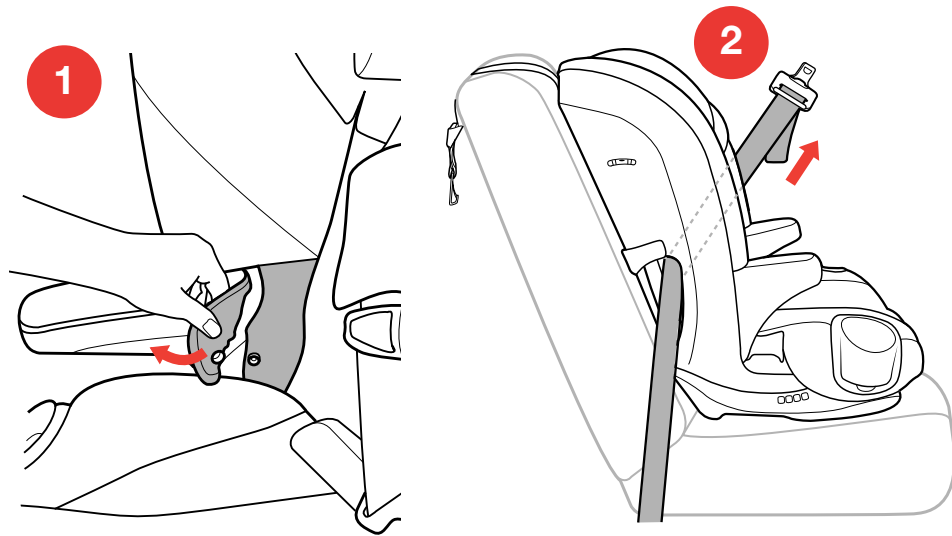

INSTALL USING LAP BELT ONLY

- 3** Lift up on the Backrest Seat Pad. Pass the vehicle belt along the back of the Child Restraint and pull the vehicle belt down through the red **HARNES MODE** seat belt path on the opposite side of the Child Restraint.
- 4** Buckle the vehicle belt. Replace the Backrest Seat Pad, make sure to re-attach the snaps on the Backrest Seat Pad to the Armrest Fabric.

INSTALL USING LAP BELT ONLY

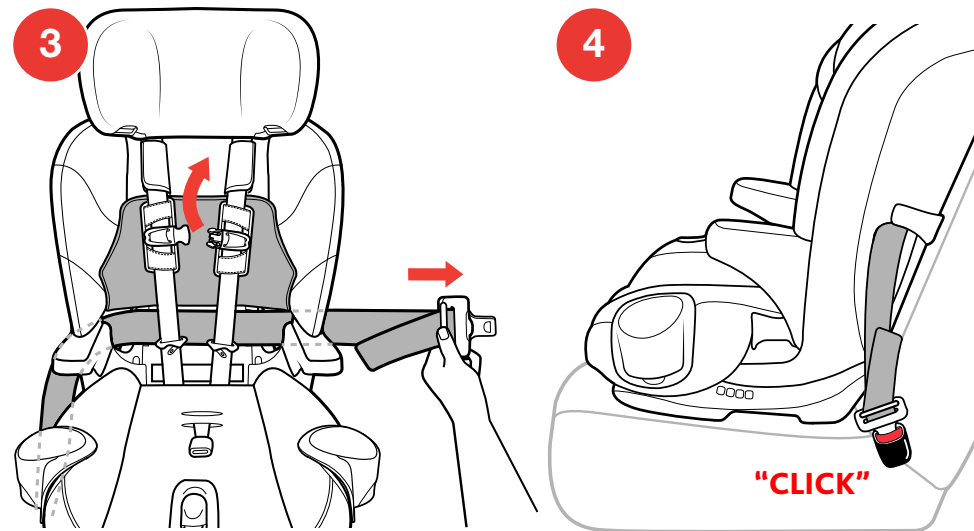

INSTALL USING LAP BELT ONLY

- 5 While pushing down on the Child Restraint (5a) pull the loose end of the vehicle lap belt (5b) to tighten.
- 6 Locate Tether anchor in your vehicle. Attach Tether Hook. Pull Tether Adjuster strap to tighten.

CHECK YOUR WORK

- ✓ Hold Child Restraint at each side near FORWARD-FACING vehicle belt path. Pull side to side and forward. Vehicle belt should remain tight and Child Restraint should not move more than 1" (25 mm) from vehicle seat back or side-to-side.
- ✓ Make sure Bubble is between lines on label. If necessary, loosen the vehicle belt and Tether, re-adjust recline and repeat installation steps to make sure Child Restraint is installed properly.
- ✓ Check installation before every use!

INSTALL USING LAP BELT ONLY

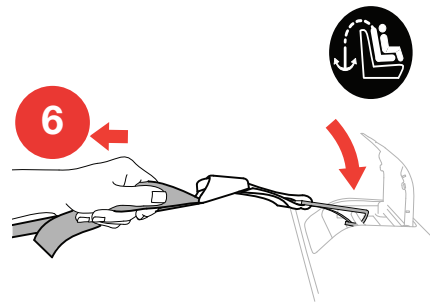
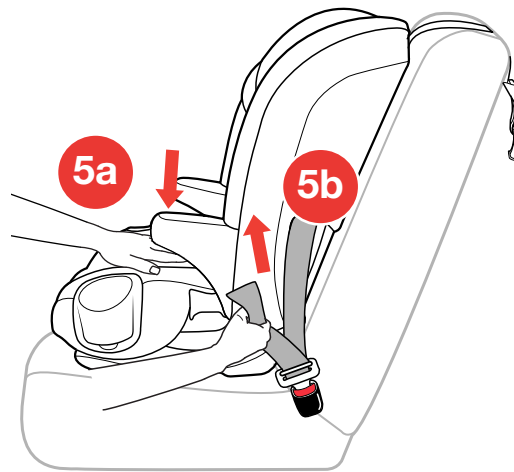

SECURING CHILD WITH HARNES

If Crotch Strap is under child, it will need to be re-positioned. Refer to page 26 "Adjusting Crotch Strap".

- 1 Loosen Harness by pressing Harness Release Button on the front of the Child Restraint and pulling out on both of the Harness Straps.
- 2 Unbuckle Harness by pressing the button on Harness Buckle and pulling out both Buckle Tongues.
- 3 Open Chest Clip by squeezing both buttons in the middle of the clip and pulling apart.

SECURING CHILD WITH HARNES

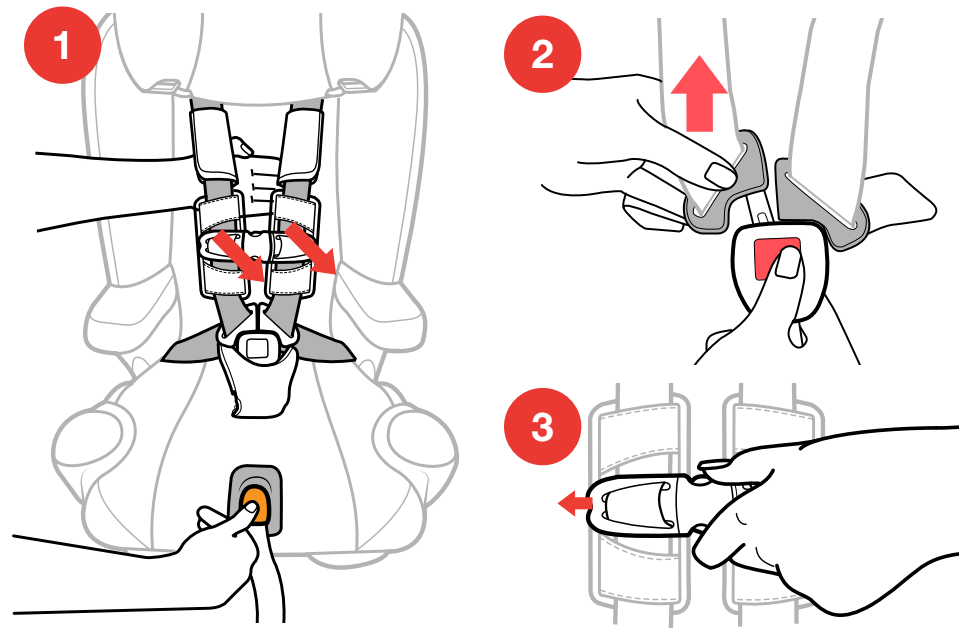

SECURING CHILD WITH HARNES

- 4 Place child in Child Restraint with child's back flat against the back of the seat. Pull Harness Straps over the child's shoulders and around the child's waist. Make sure there are no twists in Harness Strap.

Clothing, such as bulky winter coats that interfere with the proper placement or adjustment of the Harness system should never be used. Make sure the Harness Straps lie flat on the child's shoulders, are adjusted snugly so that clothing is compressed and the child cannot lean forward, and the Chest Clip is at arm level.

SECURING CHILD WITH HARNES

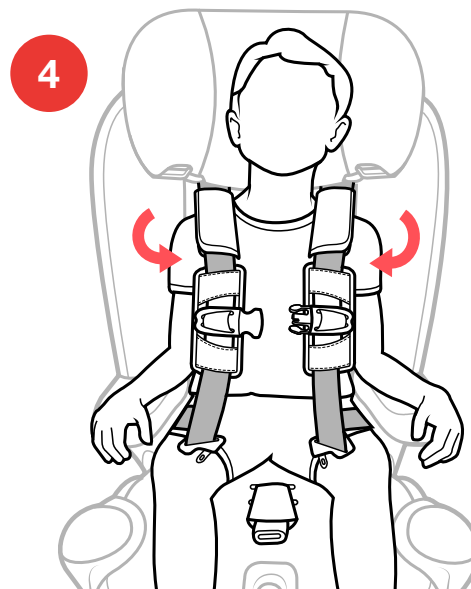

SECURING CHILD WITH HARNES

- 5 Adjust Harness Strap height position up or down by pulling up on the Headrest Adjustment Tab on the back of the Child Restraint and moving the Headrest up or down. Position the Harness Straps at or just above the child's shoulders.

Make sure Headrest locks into position before tightening Harness.

Harness may need to be loosened to move the Headrest up.

SECURING CHILD WITH HARNES

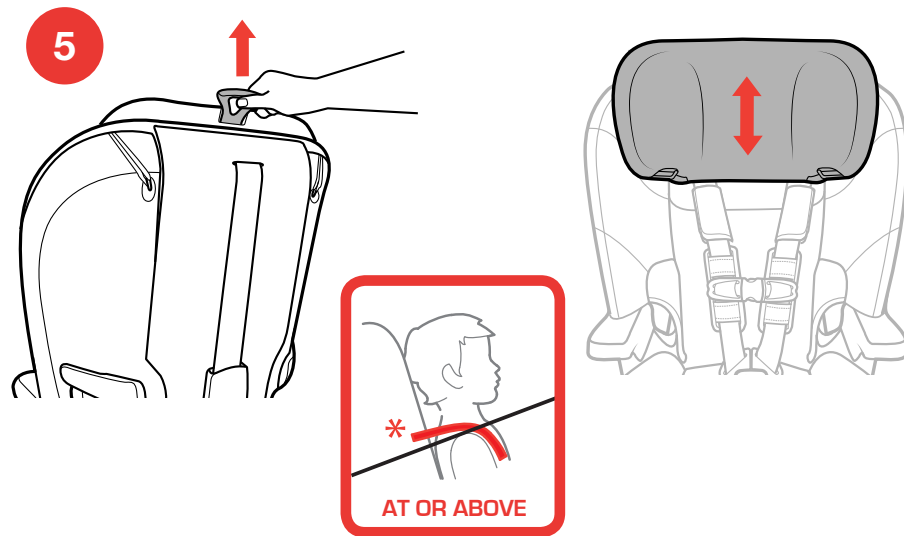

SECURING CHILD WITH HARNES

- 6 Insert each Buckle Tongue into Harness Buckle; listen for a click (6a). Pull up firmly on both Buckle Tongues to make sure that they are securely latched (6b).

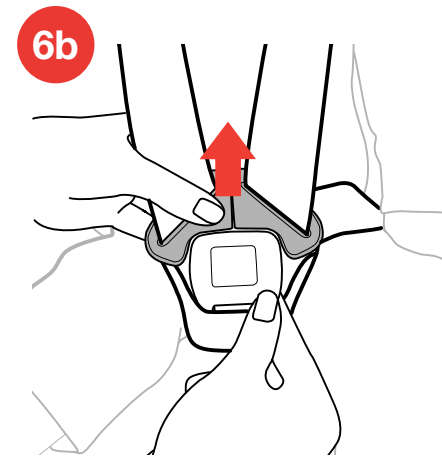
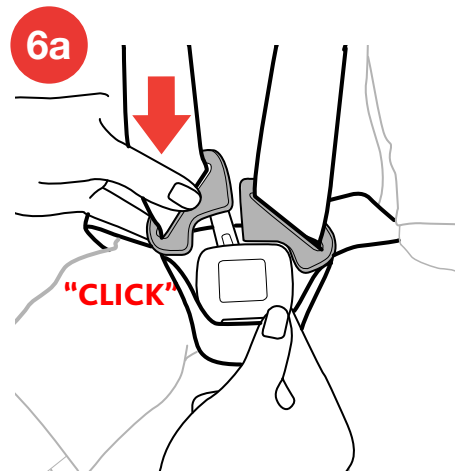

SECURING CHILD WITH HARNES

- 7 Fasten Chest Clip by snapping both sides together; listen for a click.
- 8 Push Chest Clip, Chest Clip Pads and Shoulder Pads down away from the child's neck and towards the Harness Buckle. Remove slack from the waist strap and pull up on both shoulder straps.

⚠ WARNING - Chest Clip Pads must always be used in HARNES MODE. Damaged or removed Chest Clip Pads could result in serious injury or death.

SECURING CHILD WITH HARNES

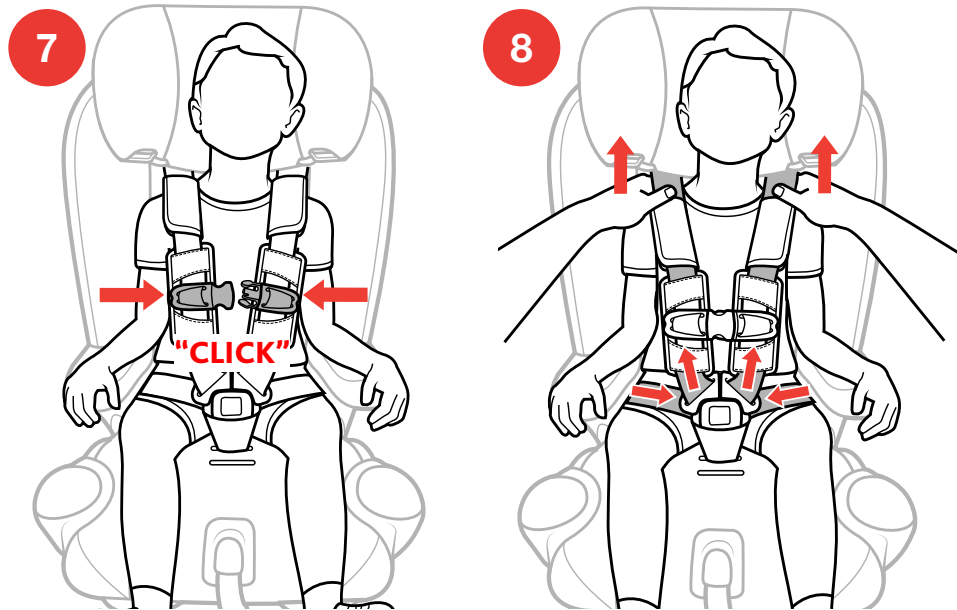

SECURING CHILD WITH HARNES

- 9** Tighten the harness by pulling slowly on Harness Adjustment Strap until the harness is snug on child (**9a**). If you can pinch a fold in the strap at the child's shoulders, harness is too loose (**9b**). If the harness is too loose pull the Harness Adjuster strap more.
- 10** Move the Shoulder Pads up to the child's shoulders. Slide Chest Clip and Chest Clip Pads up to center of child's chest, level with the armpits.

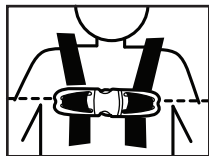

⚠ WARNING - If harness is not snug around your child, child could be ejected in a sudden stop or crash resulting in serious injury or death.

SECURING CHILD WITH HARNES

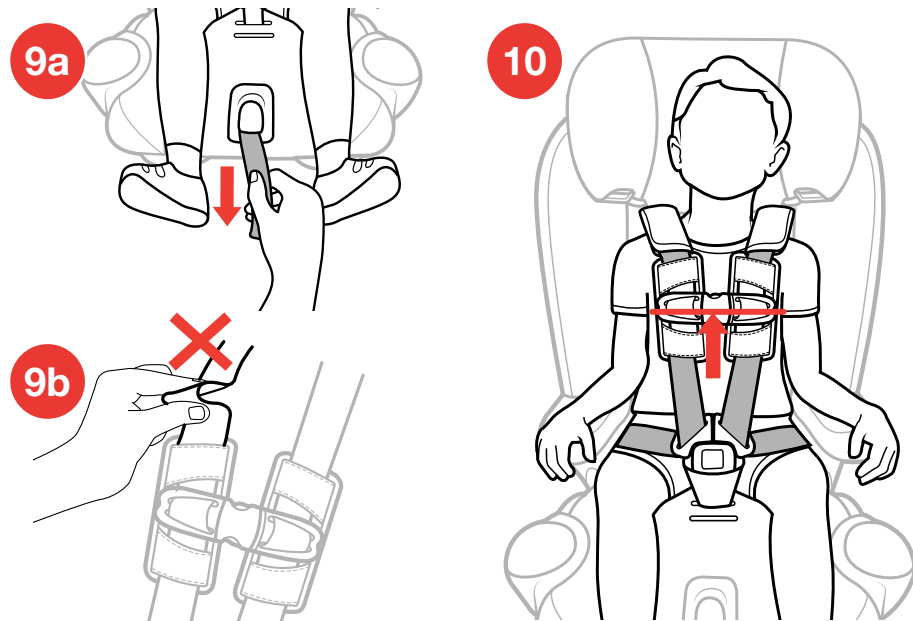

SECURING CHILD CHECKLIST

- ✓ Harness Straps must be snug. If you can pinch a fold in the strap, the harness is too loose. A snug strap should not allow any slack. It lies in a relatively straight line without sagging. It does not press on the child's flesh or push the child's body into an unnatural position.

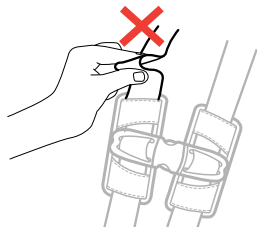

- ✓ Straps must lay flat, free of twists and centered on top of the child's shoulders.
- ✓ Check the height of the Harness Straps: Make sure to position the Harness Straps at or above the child's shoulders.



AT OR ABOVE

SECURING CHILD CHECKLIST

- ✓ Check the position of Chest Clip: Chest Clip should be centered on the child's chest, level with the armpits.
- ✓ Never secure child in Child Restraint with child dressed in bulky garments or heavy clothing. Heavy clothing can prevent harness from being properly tightened around child.
- ✓ Never secure child in Child Restraint with child wrapped in a blanket. To keep child warm, place a blanket over child AFTER you have properly secured and tightened harness around child.

⚠ WARNING - If harness is not snug around your child, child could be ejected in a sudden stop or crash resulting in serious injury or death.

BOOSTER SEAT SETUP

Store the Harness Straps and Crotch Strap properly when using the Child Restraint in BOOSTER MODE.

- 1 Completely loosen Harness by pressing Harness Release Button on the front of the Child Restraint and pulling out on both of the Harness Straps as far as possible. Then unbuckle the Chest Clip and Harness Buckle.
- 2 Unhook **BOTH** elastic straps on the back of the Child Restraint.

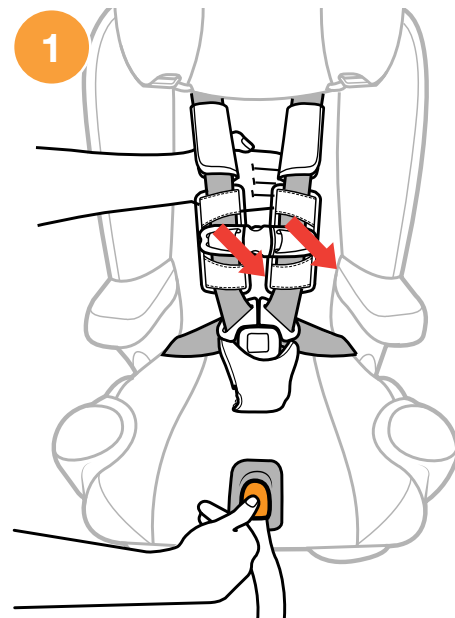

BOOSTER SEAT SETUP

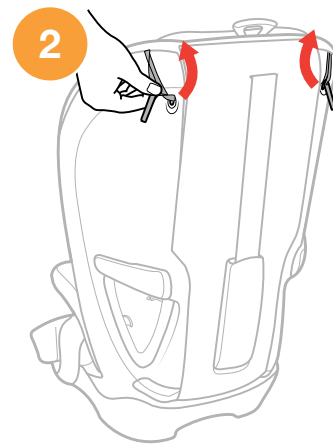

BOOSTER SEAT SETUP

- 3 Pull the fabric out from the groove around the Child Restraint. Repeat for the other side.
- 4 Unhook the elastic strap from the side hook (4a) and the top hook (4b) located near the vehicle belt path. Repeat for the other side.



BOOSTER SEAT SETUP

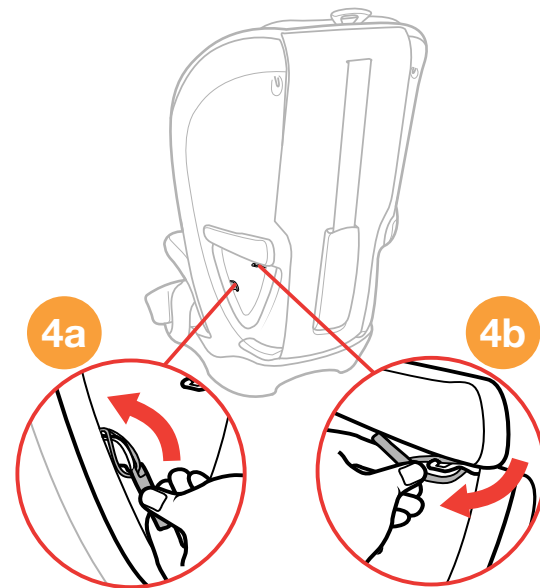

BOOSTER SEAT SETUP

- 5 Undo the snap attaching the Armrest Fabric to the Backrest Seat Pad. Repeat this step for the other side.
- 6 Remove the Backrest Seat Pad from the Child Restraint.
- 7 Lift up on the Headrest Pad, as shown.

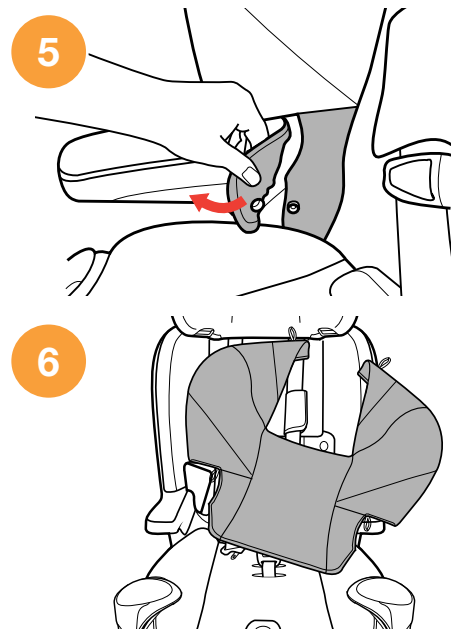

BOOSTER SEAT SETUP

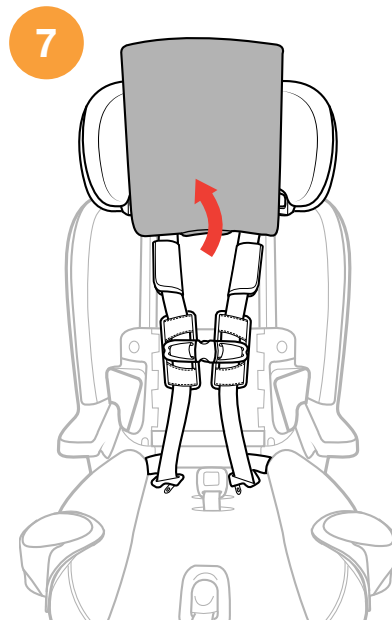

BOOSTER SEAT SETUP

- 8 Connect the Chest Clip together and slide it down to the buckle tongues. Insert the Chest Clip and the buckle tongues into the compartment at the bottom of the Seat Back.
- 9 Remove the Shoulder Pads and store them in the compartment for later use.

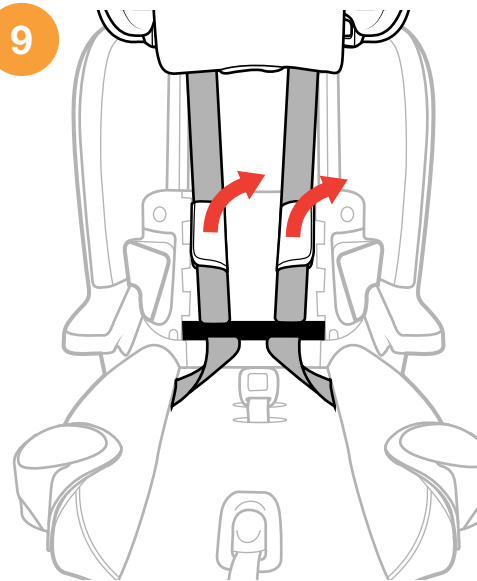
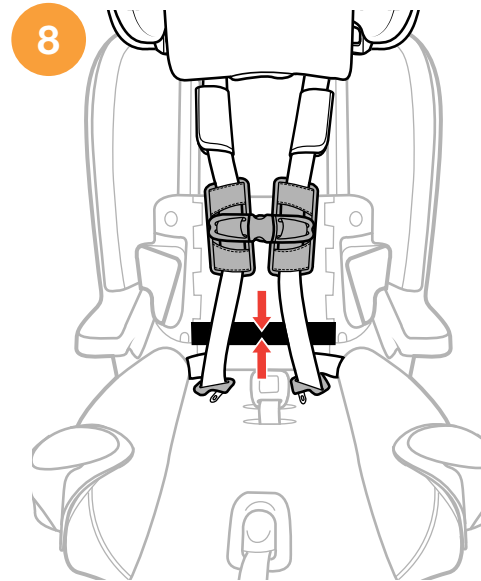

BOOSTER SEAT SETUP

- 10** Remove the Crotch Strap Pad by pushing the fabric Tab through the slot on the **BACK** of the Harness Buckle (**10a**). Then pull Tab out of the **FRONT** (**10b**) and remove Crotch Strap Pad (**10c**).
- 11** Thread the Crotch Strap through the slot in the seat pad and pull forward on the Seat Bottom pad to locate the Crotch Strap compartment.

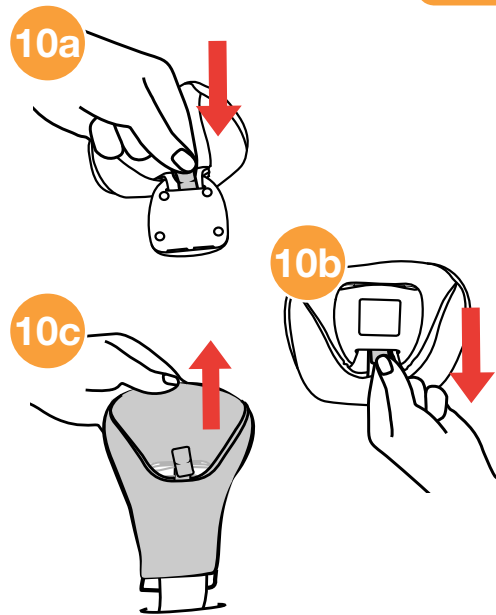

BOOSTER SEAT SETUP

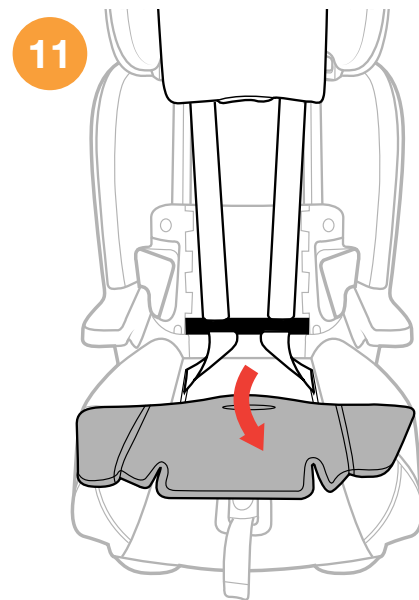

BOOSTER SEAT SETUP

- 12** To Store the Crotch Strap, fit the Crotch Strap buckle into the Crotch Strap compartment, which is located next to the crotch strap adjustment slots in the seat base (**12a**).
- 13** Repeat Booster Seat Setup Steps 2-6 (on pages 84-88) in **REVERSE** to re-attach the Backrest Seat Pad.
- 14** Reposition the Headrest Pad, as shown.

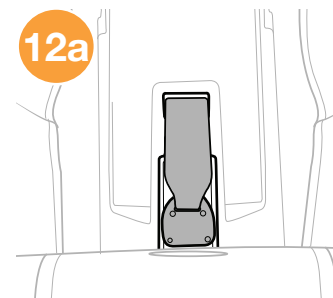
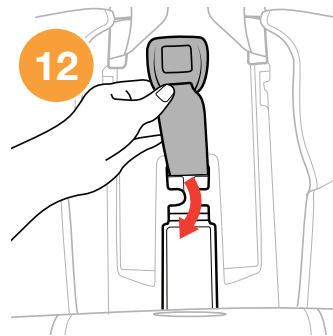

BOOSTER SEAT SETUP

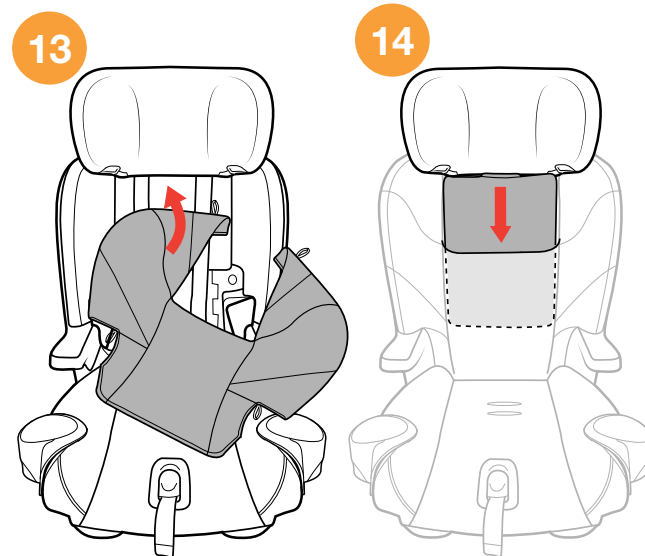

BOOSTER SEAT INSTALLATION

- 1 See page 35 for “Vehicle Seating Positions” before installing. Make sure the vehicle is on a level surface, if possible.



- 2 Place the Booster Seat on the vehicle seat making sure the installation lines (located on the Seat Base) are **PARALLEL** with the vehicle seating surface.
- 3 Check that the headrest of the vehicle seat does not interfere with the Headrest of the Booster Seat.

If the vehicle headrest pushes the Child Restraint forward, check your vehicle owner’s manual to see if the headrest removal is permitted. If so, follow the vehicle owner’s manual to remove the headrest. If it is not permitted, raise the vehicle headrest or move the Child Restraint to a different vehicle seating location.

BOOSTER SEAT INSTALLATION

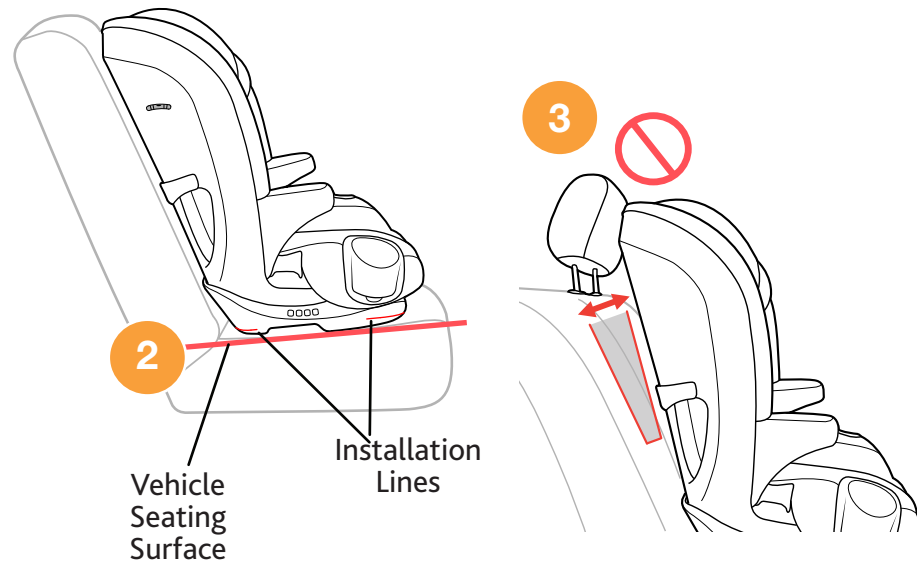

BOOSTER SEAT INSTALLATION

- 4 Make sure the Child Restraint is not blocking the vehicle belt buckle.



Installation on a Level Surface: Locate the Bubble Level Indicator label and re-adjust the seat recline to any position that the Bubble falls between the lines.



Installation on a Slope: If vehicle is on a slope, re-adjust the seat recline to position 3 or 4 only.

BOOSTER SEAT INSTALLATION

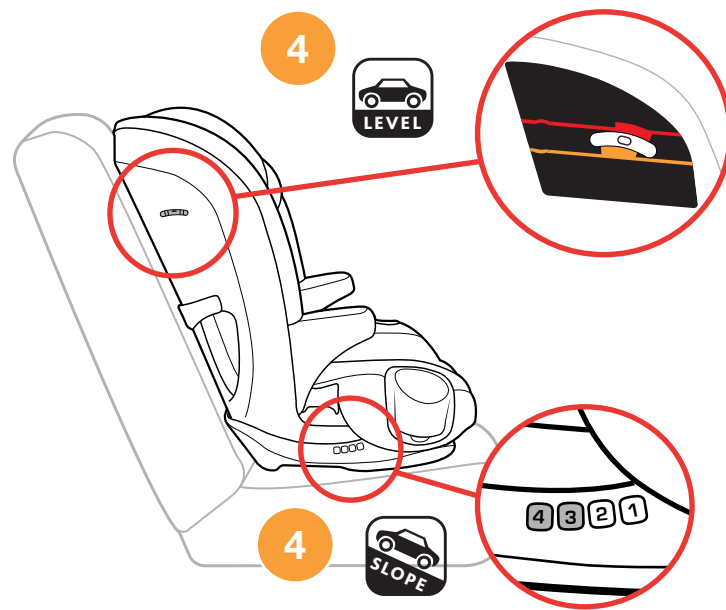

BOOSTER SEAT INSTALLATION

Use of LATCH and Top Tether in BOOSTER MODE is completely optional. If LATCH and or Tether is not used, make sure the LATCH Straps are properly stored. See page 20.

If using LATCH, locate the LATCH Connector Storage compartment and remove LATCH straps. Make sure LATCH Adjuster strap is loosened to its full length. See page 50-53.

- 5 Locate the LATCH anchor bars in your vehicle. Attach both LATCH Connectors to the vehicle LATCH anchor bars and pull tight.
- 6 Locate the Tether, attach to Tether anchor bar, and pull tight.

If the seat is not secured with both the LATCH anchors and Top Tether, the seat must be secured with the vehicle Lap-Shoulder belt when not in use.

BOOSTER SEAT INSTALLATION

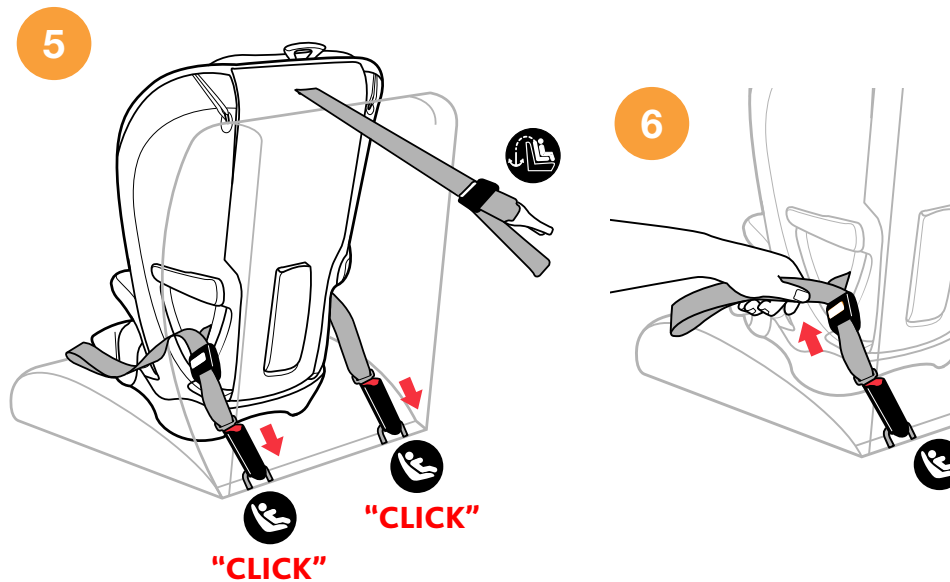

SECURING CHILD IN BOOSTER SEAT

- 1 Place the child into the Child Restraint, making sure the child is sitting with his/her back against the Backrest.
- 2 The Shoulder Belt guide must be positioned at or just slightly above the child's shoulders. If not, adjust the Headrest to the proper height. See page 28 for adjusting the Headrest Height.

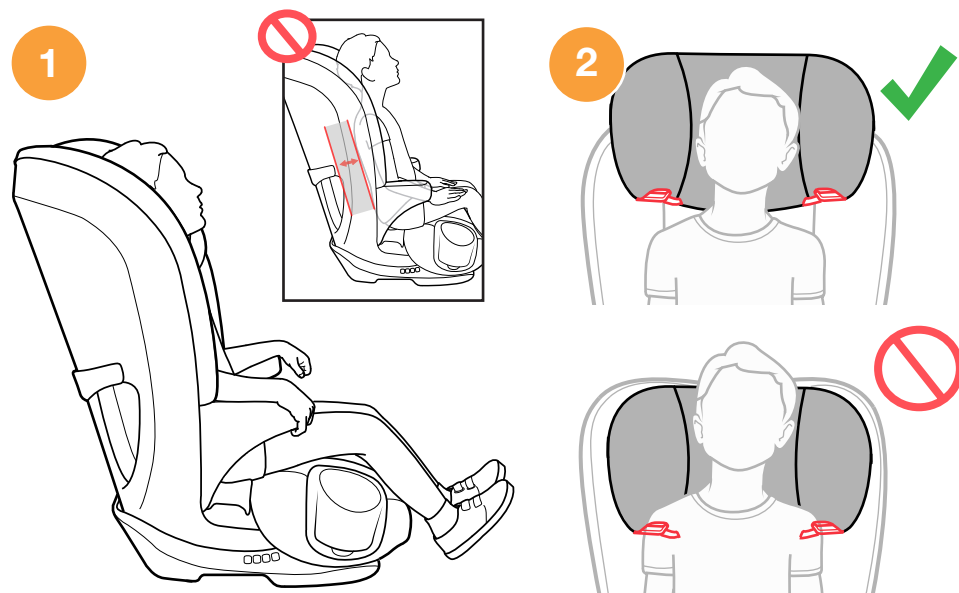

SECURING CHILD IN BOOSTER SEAT

- 3 Route the lap belt **UNDER** the 1st Armrest and across the child's thighs. Then route the shoulder belt and the lap belt **UNDER** the 2nd Armrest closest to the vehicle buckle, as shown.
- 4 Buckle the vehicle belt.

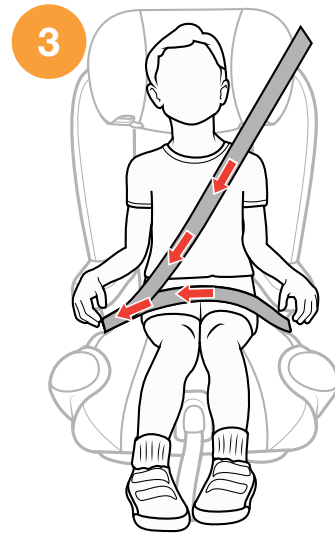

SECURING CHILD IN BOOSTER SEAT

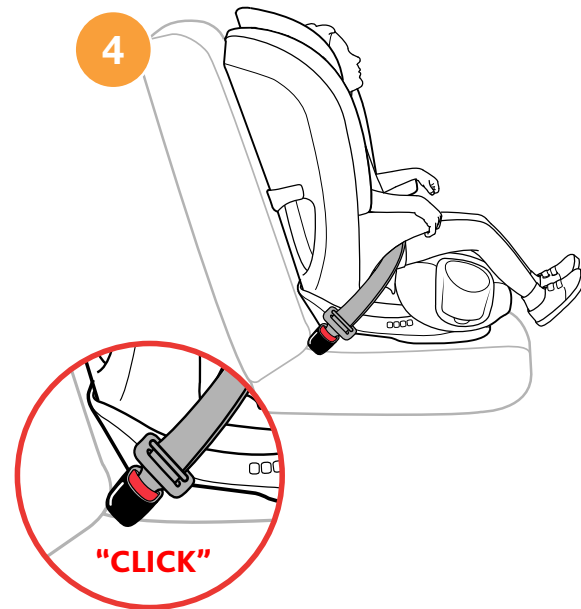

SECURING CHILD IN BOOSTER SEAT

- 5** Slide the shoulder belt between the Headrest and the side of the Seat back (**5a**). Thread the shoulder belt through the orange Shoulder Belt Guide (**5b**), located at the bottom of the headrest. Make sure the Shoulder belt lays flat and is not twisted (**5c**).

The seat belt can remain in the Shoulder Belt Clip until the seat is removed from the vehicle.

- 6** Ensure the child is secured correctly, as shown.

Check that the shoulder belt is snug on the child's shoulder and that it does not rub on the neck. It should lie flat across the child's chest and middle of shoulder. The Shoulder Belt Guide should never be below the child's shoulder. If necessary, adjust the Child Restraint Headrest to achieve a proper fit.

SECURING CHILD IN BOOSTER SEAT

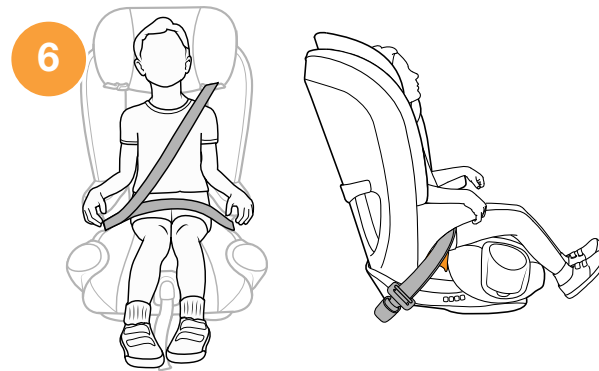
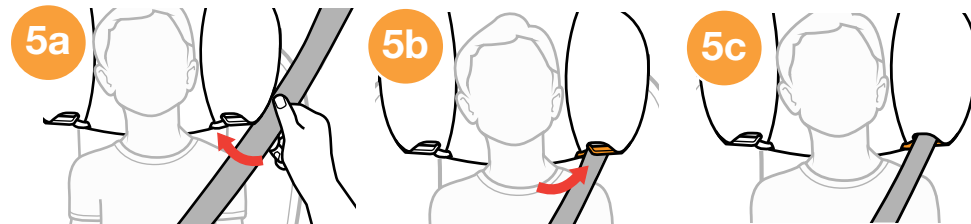

CONVERT TO HARNESS MODE

1 To convert the Booster Mode back to Harness Mode, remove the Backrest Seat Pad and lift the Headrest Pad. (Refer to pages 84-89 and complete steps 2-6)

2 Lift up on the Harness Straps and slide out the Chest Clips first, followed by the Buckle tongues.

Lift the Backrest Seat Pad and insert the Crotch Strap into the appropriate opening and then press the padding into place. Make sure the Harness Straps are arranged into the Seat Pad Grooves. Re-attach the Shoulder Pads.

3 Replace the Backrest Seat Pad by following step on page 84-89 in REVERSE.

CONVERT TO HARNESS MODE

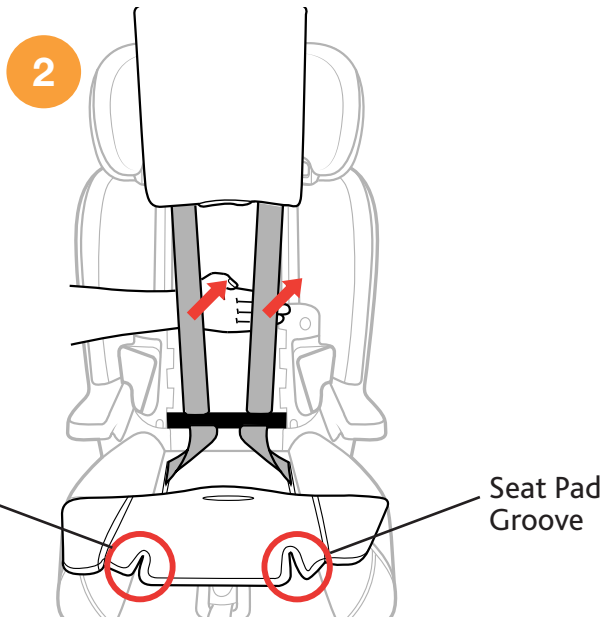

SECURING CHILD CHECKLIST

⚠️ ALWAYS check to make sure vehicle seat belt is securely buckled. If buckle separates, child could be killed or seriously injured.

- ✓ Check that the seat belt is not twisted.

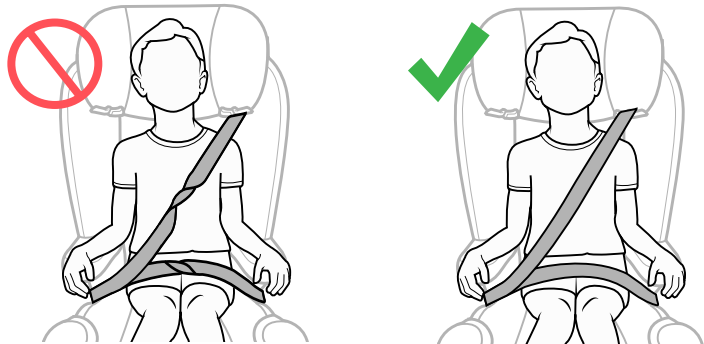

⚠️ DO NOT use anything (pillows, blankets, etc.) between the Booster Seat and the vehicle seat or between the child and the Booster Seat. Avoid bulky clothing that interferes with proper seat belt placement. In the event of an accident, the Booster Seat may not operate correctly.

SECURING CHILD CHECKLIST

- ✓ Slide the shoulder belt through the orange Shoulder Belt Guide.
- ✓ Do not let your child slide forward or downward while in the Booster Seat.
- ✓ Never use the vehicle belt in any position other than those indicated in this User Guide!

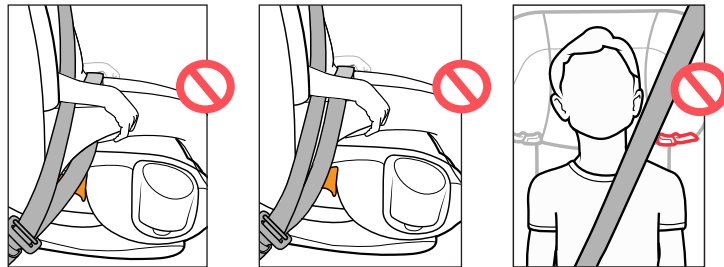

⚠️ To avoid injury to others, ALWAYS secure this child restraint in BOOSTER MODE when unoccupied. An unsecured Booster Seat could injure other occupants in a sudden stop or crash.

- ✓ Always secure the unoccupied BOOSTER SEAT with either LATCH system (see page 100) or with the vehicle belt by following the "Securing Child in BOOSTER SEAT" instructions, see page 104.

INSTALLATION ON AN AIRCRAFT

When traveling by airplane with your child, Chicco recommends taking the Child Restraint on the airplane with you so that you can use it with your child. Not only will it protect your child during take-off, landing, and turbulence, it will also allow your child to be more comfortable.

- This Child Restraint is certified for aircraft use, in **HARNES MODE ONLY**. Contact the airline prior to travel to discuss their Child Restraint policy.
- Use this Child Restraint only on FORWARD-FACING aircraft seats.
- Install Child Restraint on an aircraft the same way it is installed in a vehicle when using a vehicle lap belt. Reference Lap belt install in Harness Mode on page 66.

This restraint is **NOT** certified for aircraft use in **BOOSTER MODE**. Aircraft do not have lap-shoulder belts to secure your child.

INSTALLATION ON AN AIRCRAFT



CLEANING AND MAINTENANCE

⚠ DO NOT USE BLEACH, solvents or household cleaners as they may weaken plastics and straps.

⚠ DO NOT USE SOAPS OR LUBRICANTS on Harness Adjuster Strap, Buckle, and LATCH hardware. It may cause them to malfunction.

• **Cleaning Softgoods:**

Hand wash using mild soap and water, or machine wash in cold water on delicate cycle using mild detergent. Hang to dry.

⚠ NEVER use Child Restraint without the seat pad.

• **Cleaning Shoulder Pads:**

Hand wash using mild soap and water. Hang to dry.

• **Cleaning Plastics:**

Sponge clean using warm water and mild soap. Towel dry.

For softgood removal instructions visit the Chicco website at www.chiccousa.com or call 1-877-424-4226.

CLEANING AND MAINTENANCE

• **Cleaning Cup Holders:**

Cup Holder is dishwasher safe on top rack only.

⚠ DO NOT USE Child Restraint if any part of the harness is damaged. For proper removal and installation of the harness straps visit the Chicco website at www.chiccousa.com or call 1-877-424-4226.

• **Cleaning Harness:**

DO NOT remove the Harness Straps, Chest Clip, and Chest Clip pads. The Chest Clip Pads can be easily spot cleaned with warm water and mild soap. Air dry.

• **Cleaning LATCH and Adjuster Straps:**

Sponge clean using warm water only. Air dry.

• **Cleaning Buckle and LATCH Hardware:**

Sponge clean, using warm water only. If debris is in buckle, remove and rinse in warm cup of water only. Air dry.



Do **NOT** remove Adjuster straps. For additional information visit the Chicco website at www.chiccousa.com or call 1-877-424-4226.

